



JN516x-EK001 Evaluation Kit User Guide

JN-UG-3093
Revision 1.4
14 February 2014

**JN516x-EK001 Evaluation Kit
User Guide**

Contents

About this Manual	5
Organisation	5
Conventions	5
Acronyms and Abbreviations	6
Related Documents	6
Support Resources	6
Trademarks	6
1. Introduction to the Evaluation Kit	7
1.1 Typical Networks	8
1.2 Kit Contents	9
1.3 Kit Hardware	11
1.3.1 Remote Control Unit (DR1159)	11
1.3.2 Carrier Boards (DR1174)	12
1.3.2.1 Power Source Selection	14
1.3.2.2 Pre-assembled Boards	17
1.3.3 Lighting/Sensor Expansion Boards (DR1175)	17
1.3.4 Generic Expansion Boards (DR1199)	19
1.3.5 LCD Expansion Board (DR1215)	21
1.3.6 JN5168 Modules (JN5168-001-T0y)	22
1.3.6.1 Antenna Mounting and Connection	24
1.3.7 USB Dongles (DR1198)	26
1.3.8 Linksys Router	27
1.4 Smart Home Demonstration	29
2. Wireless Network Concepts	31
2.1 Radio Frequency	31
2.2 Node Types	32
2.3 Network Identification	32
2.4 Network Formation and Topology	33
2.4.1 Star Networks	33
2.4.2 Tree Networks	34
2.4.3 Mesh Networks	34
2.5 Wireless Network Protocol Stack	35
3. Smart Home Demonstration	37
3.1 Demo System Overview	37
3.2 Setting Up and Operating the Demo System	39

4. Where Next?	45
4.1 Which Protocol?	45
4.2 Software Developer's Kit (SDK)	46
4.2.1 SDK Toolchain (JN-SW-4041)	46
4.2.2 IEEE 802.15.4 SDK (JN-SW-4063)	47
4.2.3 JenNet-IP SDK (JN-SW-4065)	47
4.2.4 ZigBee Smart Energy SDK (JN-SW-4064)	47
4.2.5 ZigBee Home Automation SDK (JN-UG-4067)	48
4.2.6 ZigBee Light Link SDK (JN-SW-4062)	48
4.2.7 ZigBee RF4CE SDK (JN-SW-4060)	48
4.3 User Documentation	49
4.3.1 IEEE 802.15.4 Documentation	50
4.3.2 JenNet-IP Documentation	51
4.3.3 ZigBee PRO/Smart Energy Documentation	53
4.3.4 ZigBee PRO/Home Automation Documentation	54
4.3.5 ZigBee PRO/ZigBee Light Link Documentation	55
4.3.6 ZigBee RF4CE Documentation	56
Appendices	57
A. Remote Control Operations in the Demonstration	57
B. Firmware Re-programming	59
B.1 Re-programming Remote Control Unit	59
B.2 Re-programming JN5168 Modules	60
B.3 Re-programming JN5168 USB Dongles	60
B.4 Installing the FTDI Device Driver for USB Connections	61
C. Compliance Statements and Documentation	62
C.1 FCC Statements and Documentation	62
C.1.1 DR1128 FCC Documentation	64
C.1.2 DR1159 FCC Documentation	65
C.1.3 DR1174 FCC Documentation	66
C.1.4 DR1175 FCC Documentation	67
C.1.5 DR1198 FCC Documentation	68
C.1.6 DR1199 FCC Documentation	69
C.1.7 DR1215 FCC Documentation	70
C.2 Industry Canada Statements	71
C.3 CE Statements and Documentation	71

About this Manual

This manual provides an introduction to the NXP JN516x-EK001 Evaluation Kit, based around the JN516x family of wireless microcontrollers. The manual also describes how to run the pre-loaded Smart Home Demonstration using components from the kit. In addition, information is provided on the range of wireless network protocols supported by the evaluation kit and the NXP resources available to develop custom JN516x applications using these protocols.

Organisation

This manual consists of four chapters and three appendices, as follows:

- [Chapter 1](#) introduces the JN516x-EK001 Evaluation Kit.
- [Chapter 2](#) outlines the key concepts for an understanding of wireless networks.
- [Chapter 3](#) describes how to use the evaluation kit to set up and run the pre-loaded Smart Home Demonstration.
- [Chapter 4](#) provides guidance on where to go next in order to develop custom JN516x applications that can be run on the components of the kit.
- The [Appendices](#) provide:
 - A reference of the operations and associated key sequences that can be performed from the wireless Remote Control Unit
 - Guidance on re-programming the firmware of various kit components
 - Compliance statements and documentation for certain kit components

Conventions

Files, folders, functions and parameter types are represented in **bold** type.

Function parameters are represented in *italics* type.

Code fragments are represented in the `Courier New` typeface.



This is a **Tip**. It indicates useful or practical information.



This is a **Note**. It highlights important additional information.



This is a **Caution**. It warns of situations that may result in equipment malfunction or damage.

Acronyms and Abbreviations

API	Application Programming Interface
IP	Internet Protocol
JenNet	Jennic Network layer protocol
LAN	Local Area Network
PWM	Pulse Width Modulation
SDK	Software Developer's Kit
WAN	Wide Area Network
WPAN	Wireless Personal Area Network
6LoWPAN	IPv6 over Low power WPAN

Related Documents

JN-UG-3064	SDK Installation and User Guide
JN-UG-3007	JN51xx Flash Programmer User Guide
JN-AN-1162	JenNet-IP Smart Home Application Note

Support Resources

To access online support resources such as SDKs, Application Notes and User Guides, visit the Wireless Connectivity TechZone:

www.nxp.com/techzones/wireless-connectivity

All NXP resources referred to in this manual can be found at the above address, unless otherwise stated.

Trademarks

All trademarks are the property of their respective owners.

“JenNet” and “JenNet-IP” are trademarks of NXP B.V..

1. Introduction to the Evaluation Kit

Welcome to the JN516x-EK001 Evaluation Kit, which is based around the NXP JN516x family of wireless microcontrollers. A Smart Home Demonstration is pre-loaded into certain kit components, allowing a small wireless network with IP connectivity to be quickly assembled and used. The evaluation kit can also be used in conjunction with NXP's range of Software Developer's Kits (SDKs) to develop new wireless network applications for the JN516x devices using any of the following protocols:

- IEEE 802.15.4
- JenNet-IP
- ZigBee PRO (ZigBee Light Link, Home Automation and Smart Energy profiles)
- ZigBee RF4CE



Note: The pre-loaded Smart Home Demonstration is based on NXP's own JenNet-IP protocol. Demonstration applications for all the other supported protocols are available from NXP and can be run on the evaluation kit. Each is provided in an Application Note which can be downloaded from the NXP Wireless Connectivity TechZone (see [“Support Resources” on page 6](#)). For more details, refer to [Chapter 4](#).

This chapter introduces you to the evaluation kit by describing:

- Typical wireless networks - see [Section 1.1](#)
- Contents of the kit - see [Section 1.2](#)
- Hardware features of the kit - see [Section 1.3](#)
- Pre-loaded demonstration - see [Section 1.4](#)

1.1 Typical Networks

The JN516x-EK001 Evaluation Kit can be used as a platform for developing a wide range of wireless network applications, where these applications run on JN516x devices embedded in the network nodes. Example networks are:

- A simple point-to-point network consisting of only two nodes - for example, a wireless radio link between a remote control unit and a media player (e.g. using the ZigBee RF4CE protocol)



Figure 1: Point-to-Point Wireless Link

- A wireless network consisting of many nodes - for example, a wirelessly controlled heating system in a building (e.g. using a ZigBee PRO profile)

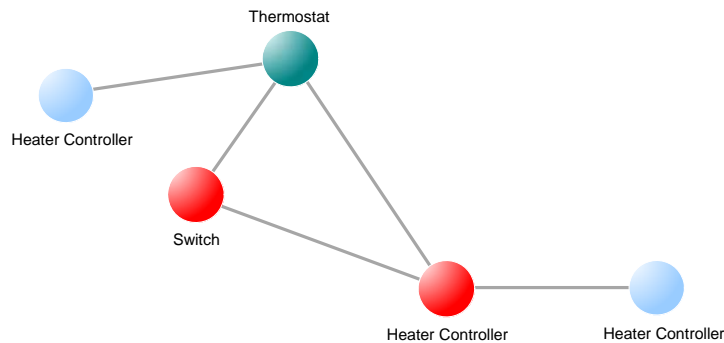

Figure 2: Wireless Network

- A wireless network with IP connectivity - for example, a wirelessly controlled home lighting system that can also be accessed from the Internet (e.g. using the JenNet-IP protocol)

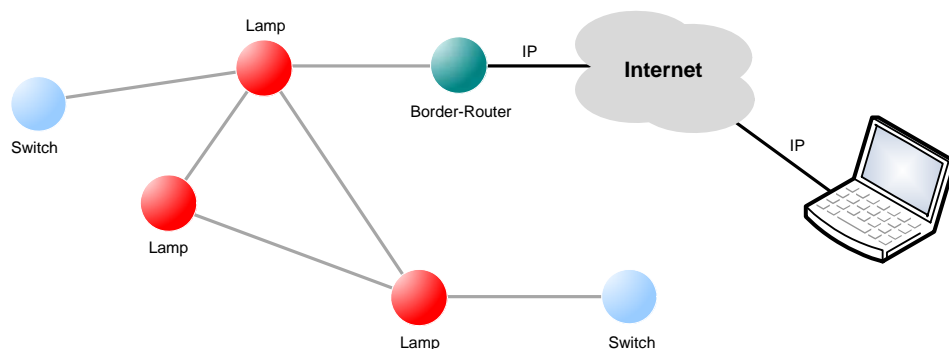

Figure 3: Wireless Network with IP Connectivity

The supported wireless network protocols are more fully introduced in [Chapter 4](#).

1.2 Kit Contents

In the kit, you will find the following components (numbers refer to [Figure 4](#)):

1. Linksys Wireless-N Broadband Router (WRT160NL)
2. 12V DC power supply unit (universal type) for Linksys router
3. 2 antennas with SMA connectors for Linksys router
4. RJ45 Ethernet cable for Linksys router
5. USB Type-A extension cable for Linksys router
6. 2 JN5168 USB Dongles with integrated antenna (DR1198)
7. 4 Carrier Boards (DR1174):
 - 1 pre-fitted with a Generic Expansion Board (DR1199) and a JN5168 standard-power module with uFL connector (JN5168-001-T03)
 - 3 pre-fitted with a Lighting/Sensor Expansion Board (DR1175) and a JN5168 standard-power module - two with integrated antenna (JN5168-001-T00), one with uFL connector (JN5168-001-T03)
8. Generic Expansion Board (DR1199)
9. LCD Expansion Board (DR1215)
10. 4 JN5168 high-power modules with uFL connector:
 - 2 JN5168-001-T05 modules for worldwide use
 - 2 JN5168-001-T06 modules for use in North America (FCC and IC) only
11. Remote Control Unit (DR1159), based on the JN5168 wireless microcontroller
12. Programming Dongle (DR1128) for Remote Control Unit
13. 4 antennas with fly-leads for modules with uFL connectors
14. 5-way 2.1mm daisy-chain power extender-cable
15. 3 'USB A to Mini B' cables
16. 2 packs of AAA batteries

As noted above, the four Carrier boards are pre-fitted with expansion boards and JN5168-based modules. Details of the supplied combinations are provided in [Table 1 on page 10](#).



Note: A JN5168-001-T0y component comprises a JN5168-001-M0y module mounted on a (short) Mezzanine Board of the type DR1179. It is labelled JN5168-001-M0y.



Figure 4: JN516x-EK001 Evaluation Kit Components

	Expansion Board Fitted	Module Fitted *	Antenna Provision on Module
1	Lighting/Sensor (DR1175)	JN5168-001-T00	Integrated antenna
2	Lighting/Sensor (DR1175)	JN5168-001-T00	Integrated antenna
3	Lighting/Sensor (DR1175)	JN5168-001-T03	uFL connector for external antenna
4	Generic (DR1199)	JN5168-001-T03	uFL connector for external antenna

Table 1: Supplied Carrier Board Configurations

* Each module is mounted on a DR1179 Mezzanine Board, which is mounted on the Carrier Board.

The pre-fitted JN5168 modules, the JN5168 USB Dongles and the Remote Control Unit of this evaluation kit are pre-programmed with the relevant binaries for the JenNet-IP Smart Home Demonstration (see [Section 1.4](#)). However, the JN5168 high-power modules are not pre-programmed with any application.

The Linksys router is pre-programmed with an NXP firmware update.

1.3 Kit Hardware

This section details the hardware devices supplied in the JN516x-EK001 Evaluation Kit (see [Section 1.2](#) for full kit contents):

- Remote Control Unit (and Programming Dongle) - see [Section 1.3.1](#)
- Carrier Boards - see [Section 1.3.2](#)
- Lighting/Sensor Expansion Boards - see [Section 1.3.3](#)
- Generic Expansion Boards - see [Section 1.3.4](#)
- LCD Expansion Board - see [Section 1.3.5](#)
- JN5168 modules - see [Section 1.3.4](#)
- JN5168 USB Dongles - see [Section 1.3.7](#)
- Linksys router - see [Section 1.3.8](#)

1.3.1 Remote Control Unit (DR1159)

The Remote Control Unit (part number: DR1159) is designed around the JN5168 device and features a 16-button capacitive-touch keypad. The unit is designed as a wireless network node which can be used to control other nodes of the network.

The unit has the following features:

- 16 capacitive-touch buttons in a 4x4 keypad with configurable functions
- Separate 'Wake' button (below keypad) to bring unit out of sleep mode
- 2 green ultra low-power LEDs
- Powered by 2 AAA batteries
- Firmware programming through header accessed via the battery compartment (programmed via supplied dongle - see below)

The front of the unit is shown in [Figure 5](#), along with the Programming Dongle (part number: DR1128). Firmware re-programming of the Remote Control Unit is described in [Appendix B.1](#).

The battery compartment is accessed via a slide-cover on the rear of the unit. The required battery polarities are indicated on the inside of the compartment.

To return the Remote Control Unit to the factory settings at any time, enter the following key sequence into the unit: **# 0 - 0**



Figure 5: DR1159 Remote Control Unit (and DR1128 Programming Dongle)

1.3.2 Carrier Boards (DR1174)

The four carrier boards (part number: DR1174) are physically identical. They are all pre-fitted with an Arduino-compatible expansion board and a JN5168-based module, but they are not all fitted with the same types of expansion board and module - the hardware configurations of the four Carrier Boards are detailed in Table 1 on page 10.



Note 1: The Carrier Boards are supplied with the correct hardware configurations for the pre-loaded JenNet-IP Smart Home Demonstration. Once you have run this demonstration, you can re-configure the Carrier Boards as you wish - for example, by replacing a fitted module with one of the supplied high-power modules and/or replacing one of the expansion boards with the supplied LCD Expansion Board.

Note 2: For full details of the board, refer to the *Carrier and Expansion Boards Reference Manual (JN-RM-2063)*, available from the NXP Wireless Connectivity TechZone (see “[Support Resources](#)” on page 6).

Each Carrier Board has the following features (also refer to [Figure 6](#) and [Figure 7](#)):

- JN51xx module site
- Arduino-compatible header (in four parts)
- 10-way JTAG debug header
- PCB pads for 40-way expansion header
- Analogue interface header for access to JN51xx DACs and comparators
- USB Mini B port for JN51xx module programming or UART connection
- FTDI FT232 driver chip for USB port
- On-board 4-Mbit Flash memory device (connected to SPISSZ line of module)
- On-board 32-kHz crystal oscillator (connected across DIO9 and DIO10 of module but not routed to Arduino-compatible header)
- 2 apertures for push-through antennas (see [Section 1.3.6.1](#))
- Reset button
- User-input button (SW1 connected to DIO8 of module)
- 3 green ultra low-power LEDs for Power, UART Tx and UART Rx
- 2 green LEDs for debug purposes (connected to DIO2 and DIO3 of module)
- Powered from one of the following (see [Section 1.3.2.1](#)):
 - 4 AAA batteries on the board
 - 2 AAA batteries (low-power mode) on the board
 - External 7-12V DC supply
 - External device via USB port

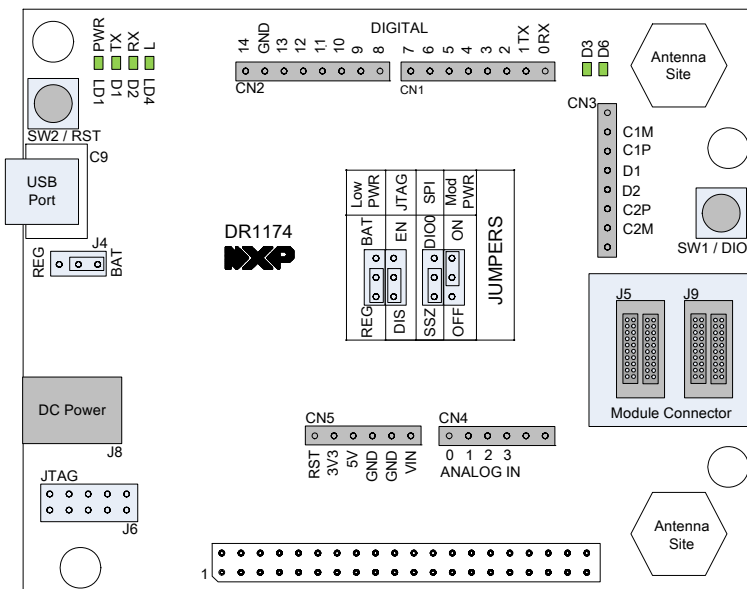

Figure 6: DR1174 Carrier Board Layout

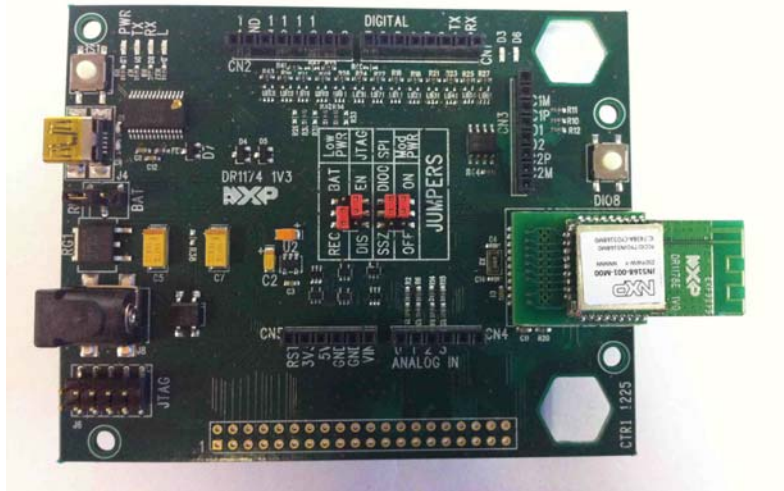

Figure 7: DR1174 Carrier Board (with a JN516x Module)

Note the following:

- The expansion board is an Arduino-compatible shield attached to the Arduino-compatible header.
- The JN5168-based module which is pre-fitted to the module site has been pre-loaded with the JenNet-IP Smart Home demonstration.
- An antenna aperture can accommodate one of the supplied push-through antennas and is for use with a module that uses a uFL antenna connection (see [Section 1.3.4](#)).
- In low-power mode, which uses just 2 AAA batteries, only the JN516x module is powered (this mode can be used to make low-current measurements).
- The board is supplied with the **SPI** jumper in the **SSZ** position in order to enable access to the on-board Flash memory device for applications that need it
- To return to the factory settings (including for the fitted module), wait at least 2 seconds following power-up, then press the Reset (RST) button on the Carrier Board 4 times with less than 2 seconds between two consecutive presses.

1.3.2.1 Power Source Selection

The board can be used in normal-power mode or low-power mode, selected using the **J4** and **Low PWR** jumpers. For the locations of these jumpers, refer to [Figure 8](#).



Note: The **Low PWR** jumper is hidden under the expansion board, which must be removed in order to change the jumper setting - there are two jumper positions, **BAT** and **REG**.

 **Note:** If batteries are being used and the board is going to be left in the idle state for a significant length of time, the batteries should be removed in order to conserve their power.

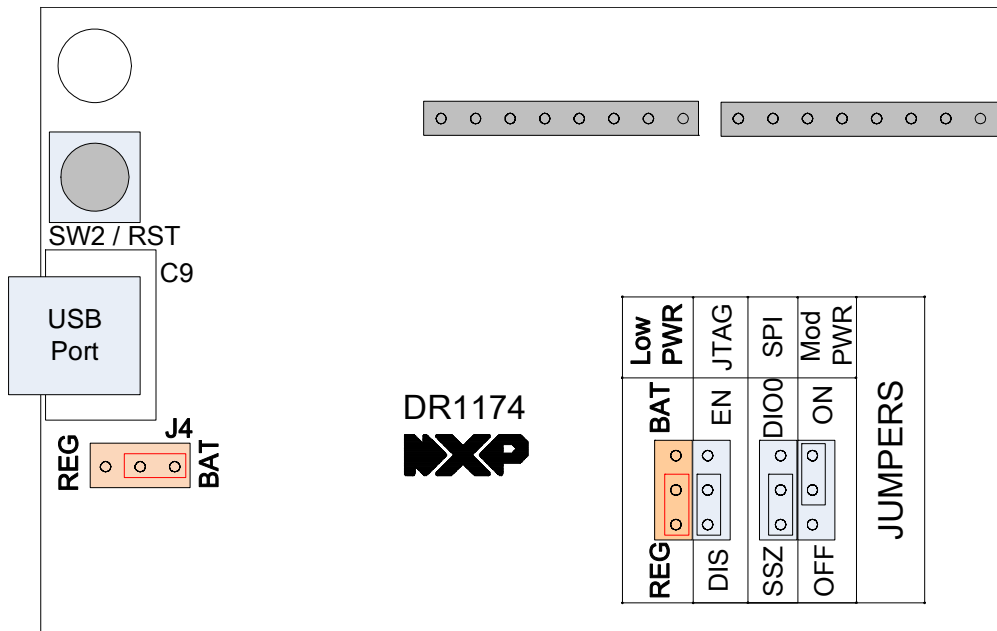

Figure 8: Locations of Power Selection Jumpers (J4 and Low PWR)

Normal-Power Mode

In normal-power mode, the board can be powered from one of the following:

- 4 AAA batteries, connected on the underside of the board
- External 7-12V DC supply via 2.1-mm connector
- External device via USB Mini B connector

The voltage regulator must be selected for the external DC and USB power supplies by putting the jumper **J4** into the **REG** position, as illustrated in [Figure 9](#) - the regulator is not needed for battery power. However, for all sources in normal-power mode, the **Low PWR** jumper must be put in the **REG** position (see [Low-Power Mode](#) below).

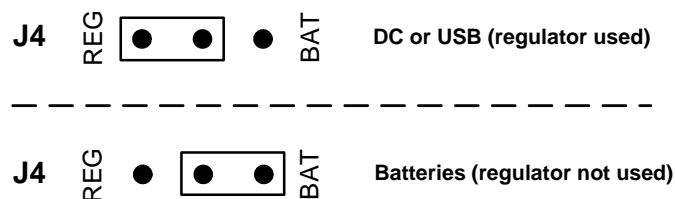

Figure 9: Regulator Selection (using J4 Jumper)



Caution: When using an external DC Power Supply Unit (PSU) with a Carrier Board, only a **7-12V** PSU with a 2.1-mm connector must be used. The PSU provided for the Linksys router can be used for a Carrier Board.



Note: The four Carrier Boards and Linksys router can be powered from the same PSU by using the supplied 5-way daisy-chain power cable to link them together.

Low-Power Mode

In low-power mode, the board is powered from 2 AAA batteries connected in the lower two battery holders (nearest to the 40-way header) on the underside of the board. In this mode, only the JN516x module is powered (this mode can be used to make low-current measurements). To select low-power mode, the **Low PWR** jumper must be put in the **BAT** position, as illustrated in [Figure 10](#). The jumper J4 (used in normal-power mode) has no effect in low-power mode and can be left in any position.

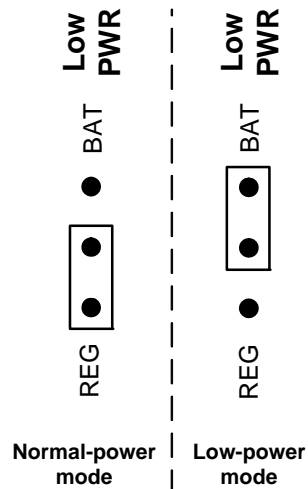

Figure 10: Lower-Power Mode Selection (using Low PWR Jumper)

1.3.2.2 Pre-assembled Boards

As indicated above, each Carrier Board is supplied pre-fitted with a JN5168 module and an expansion board. [Figure 11](#) below shows a pre-assembled board carrying a module with integrated antenna.



Figure 11: Carrier Board Fitted with Module and Expansion Board

The expansion boards are described in [Section 1.3.3](#), [Section 1.3.4](#) and [Section 1.3.5](#). The modules are described in [Section 1.3.6](#), which also describes how to fit an external antenna.

1.3.3 Lighting/Sensor Expansion Boards (DR1175)

The three Lighting/Sensor Expansion Boards (part number: DR1175) are physically identical. They are Arduino-compatible shields that are supplied pre-fitted to the Arduino-compatible headers of three of the Carrier Boards (see [Section 1.3.2](#)).



Note: For full details of the board, refer to the *Carrier and Expansion Boards Reference Manual (JN-RM-2063)*, available from the NXP Wireless Connectivity TechZone (see [“Support Resources”](#) on [page 6](#)).

Each expansion board has the following features (also refer to [Figure 12](#)):

- Arduino-compatible expansion header (in four parts, CN1-CN4)
- 3 white dimmable LEDs:
 - Controlled in unison by Pulse Width Modulation (PWM)
 - Driven by the PWM output of JN516x Timer 1 on the module on the Carrier Board, via DIO3 on the module (for details of the JN516x timers and DIOs, refer to the datasheet for the appropriate chip).

Chapter 1
Introduction to the Evaluation Kit

- Colour LED module containing 3 miniature LEDs:
 - LEDs are independently controlled by PWM from an on-chip multi-channel PMW controller, connected via the 2-wire Serial Interface (see below)
 - Connected to the 2-wire Serial Interface (I²C) of the module on the Carrier Board, via DIO14 (clock) and DIO15 (data) on the module
- Humidity/temperature sensor (of the type SHT1x) connected to the module on the Carrier Board, via DIO12 (data) and DIO17 (clock) on the module
- Light sensor (of the type TSL2550), connected to the 2-wire Serial Interface (I²C) of the module on the Carrier Board, via DIO14 (clock) and DIO15 (data) on the module
- Reset button (to reset the Carrier Board)

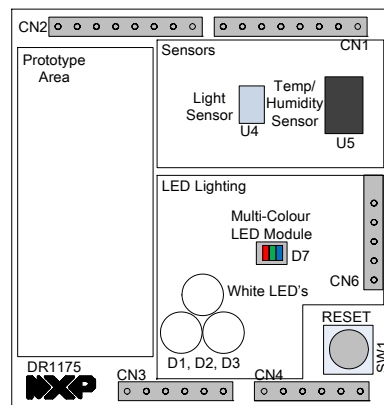

Figure 12: DR1175 Lighting/Sensor Expansion Board Layout

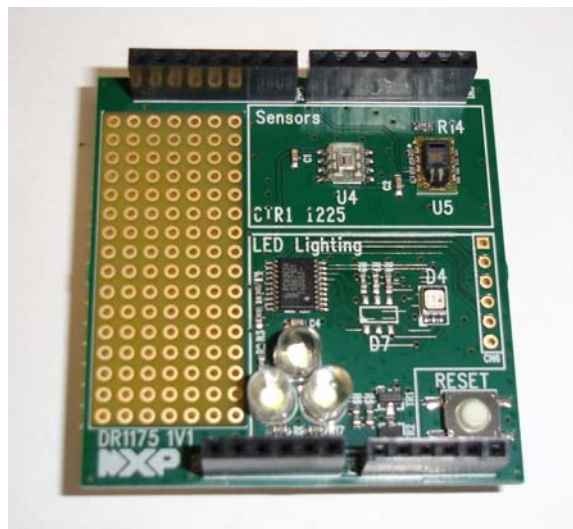

Figure 13: DR1175 Lighting/Sensor Expansion Board



Caution: *The LEDs on the Lighting/Sensor Expansion Board are very bright at maximum intensity. To avoid damage to your eyes, do not look into them directly for an extended period of time.*

1.3.4 Generic Expansion Boards (DR1199)

The two Generic Expansion Boards (part number: DR1199) are physically identical. They are Arduino-compatible shields and one is pre-fitted to the Arduino-compatible header on a Carrier Board.



Note: For full details of the board, refer to the *Carrier and Expansion Boards Reference Manual (JN-RM-2063)*, available from the NXP Wireless Connectivity TechZone (see [“Support Resources” on page 6](#)).

Each expansion board has the following features (also refer to [Figure 14](#)):

- Arduino-compatible expansion header (in four parts, CN1-CN4)
- 4 user-input buttons (SW1, SW2, SW3, SW4):
 - SW1 is connected to DIO1 of module
 - SW2 is connected to DIO11 of module
 - SW3 is connected to DIO12 of module
 - SW4 is connected to DIO17 of module
- 4 LEDs (D1, D2, D3, D4):
 - D1 is connected to DIO0 of module
 - D2 is connected to DIO13 of module (same as for the PWM output used on the Lighting/Sensor Expansion Board to drive the three white LEDs)
 - D3 is connected to DIO16 of module
 - D4 is an optional LED which is not fitted on the supplied board and shares DIO1 with button SW1
- Potentiometer connected to JN51xx ADC1, providing a 0-1.8V DC voltage swing
- USB Mini B port to provide access to JN51xx UART1 via DIO14 and DIO15 of module (or alternatively to UART0 on a JN516x device)
- FTDI FT232 driver chip for USB port
- PCB pads for 4-way GPIO header (3V3, VCC, DIO14, DIO15), where DIO14 and DIO15 can be used to access JN51xx UART1 (in this case, the FTDI driver chip for the USB port must be isolated by removing resistors R11 and R12)

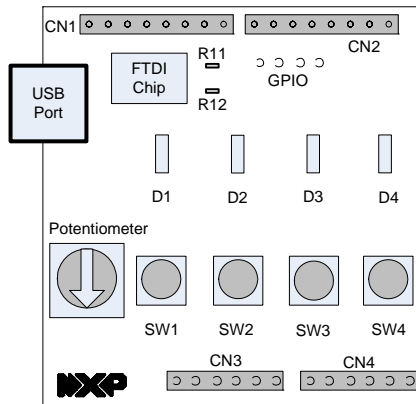

Figure 14: DR1199 Generic Expansion Board Layout



Figure 15: DR1199 Generic Expansion Board

1.3.5 LCD Expansion Board (DR1215)

The LCD Expansion Board (part number: DR1215) is supplied for applications that need to provide on-screen feedback to the user. It is an Arduino-compatible shield but is not pre-fitted to a Carrier Board.



Note 1: For full details of the board, refer to the *Carrier and Expansion Boards Reference Manual (JN-RM-2063)*, available from the NXP Wireless Connectivity TechZone (see [“Support Resources” on page 6](#)).

Note 2: The LCD Expansion Board DR1215 has replaced DR1201, which is now obsolete since its LCD panel is no longer available. The latest NXP JN516x SDKs support both boards. The functionality of the two boards is the same and this update will not affect application code. The driver automatically detects which board is being used through an additional IO signal which is present on the DR1215 board.

This expansion board has the following features:

- Arduino-compatible expansion header (in four parts, CN1-CN4)
- 128 x 64 monochromatic LCD panel (driven from SPI bus)
- 4 user-input buttons (SW1, SW2, SW3, SW4):
 - SW1 is connected to DIO1 of module
 - SW2 is connected to DIO11 of module
 - SW3 is connected to DIO12 of module
 - SW4 is connected to DIO17 of module

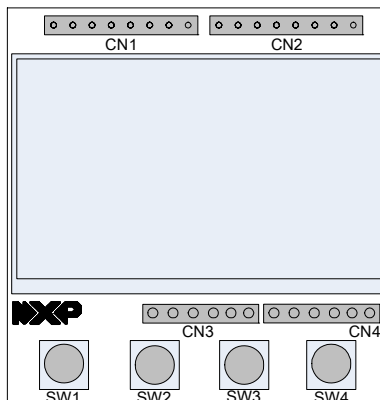

Figure 16: DR1215 LCD Expansion Board Layout



Figure 17: DR1215 LCD Expansion Board

1.3.6 JN5168 Modules (JN5168-001-T0y)

Four types of JN5168-based module are supplied in the kit. Each type is a JN5168-001-M0y module mounted on a (short) Mezzanine Board (DR1179), the part number of the combined component being JN5168-001-T0y.

- **JN5168-001-T00 (JN5168-001-M00 mounted on Mezzanine Board)**

Two of these modules are supplied, pre-fitted on Carrier Boards. The module features a JN5168-001 wireless microcontroller and an integrated PCB antenna.
- **JN5168-001-T03 (JN5168-001-M03 mounted on Mezzanine Board)**

Two of these modules are supplied, pre-fitted on Carrier Boards. The module features a JN5168-001 wireless microcontroller. A uFL connector is used to connect the module to an antenna on the Carrier Board via a fly lead (see below).
- **JN5168-001-T05 (JN5168-001-M05 mounted on Mezzanine Board)**

Two of these modules are supplied. The module features a JN5168-001 wireless microcontroller and provides a 10dBm high-power output, suitable for worldwide use. As a high-power module, it can be used to replace a pre-fitted standard-power module in order to achieve a larger radio transmission range. A uFL connector is used to connect the module to an antenna on the Carrier Board via a flying lead (see below). Intended for worldwide markets.
- **JN5168-001-T06 (JN5168-001-M06 mounted on Mezzanine Board)**

Two of these modules are supplied. The module features a JN5168-001 wireless microcontroller and provides a 22dBm high-power output, intended only for the North American (FCC and IC) markets. As a high-power module, it can be used to replace a pre-fitted standard-power module in order to achieve

a larger radio transmission range. A uFL connector is used to connect the module to an antenna on the Carrier Board via a flying lead (see below).



Caution: The JN5168-001-TO6 high-power module is intended only for use in the North American (FCC and IC) markets. It is not compliant for use in Europe.



Note: The JN5168 modules that are pre-fitted to Carrier Boards are pre-programmed with the JenNet-IP Smart Home Demonstration. The other JN5168 modules are not pre-programmed and are not intended for use in the demonstration. Firmware programming of JN516x modules is described in [Appendix B.2](#).



Figure 18: JN5168 Modules

1.3.6.1 Antenna Mounting and Connection

The JN5168 modules with uFL connectors must be used with the supplied antennas. An antenna is provided with a 7-cm fly lead attached, which allows the antenna to be connected to the module. To mount and connect an antenna, proceed as follows (also refer to [Figure 19](#) and [Figure 20](#)):

1. Take an antenna and detach the base piece from the antenna.
2. Push the antenna base piece into a hexagonal hole on the Carrier Board from the rear of the board until the collar is flush with the board. *The 'locating lugs' of the antenna base piece should be parallel to the top or bottom of the board, as illustrated in [Figure 20](#).*
3. Thread the fly lead (which is attached to the antenna) through the base piece, from front to back.
4. Continue feeding the attached antenna into the base piece from the front, moving it slightly until it clicks into the slot (push the antenna firmly into place).
5. Connect the free end of the fly lead to the uFL connector on the module.



Caution: *Once you have mounted an antenna on a board, do not remove it as the antenna assembly is fragile and may be damaged on removal.*

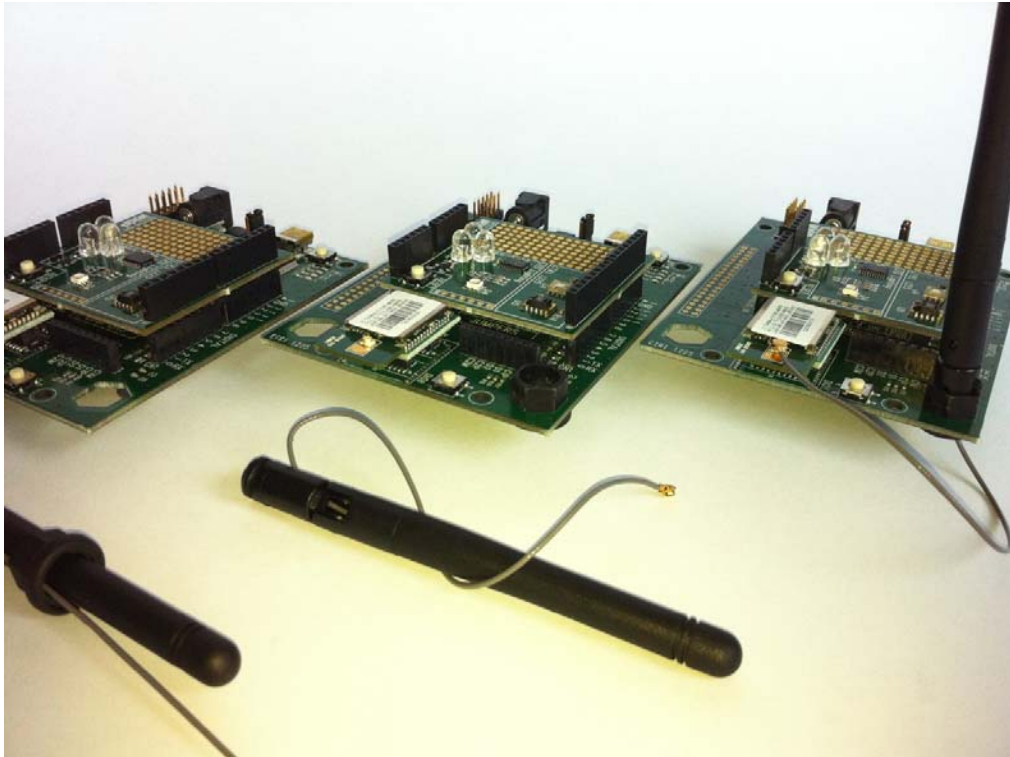

Figure 19: Stages of Antenna Mounting

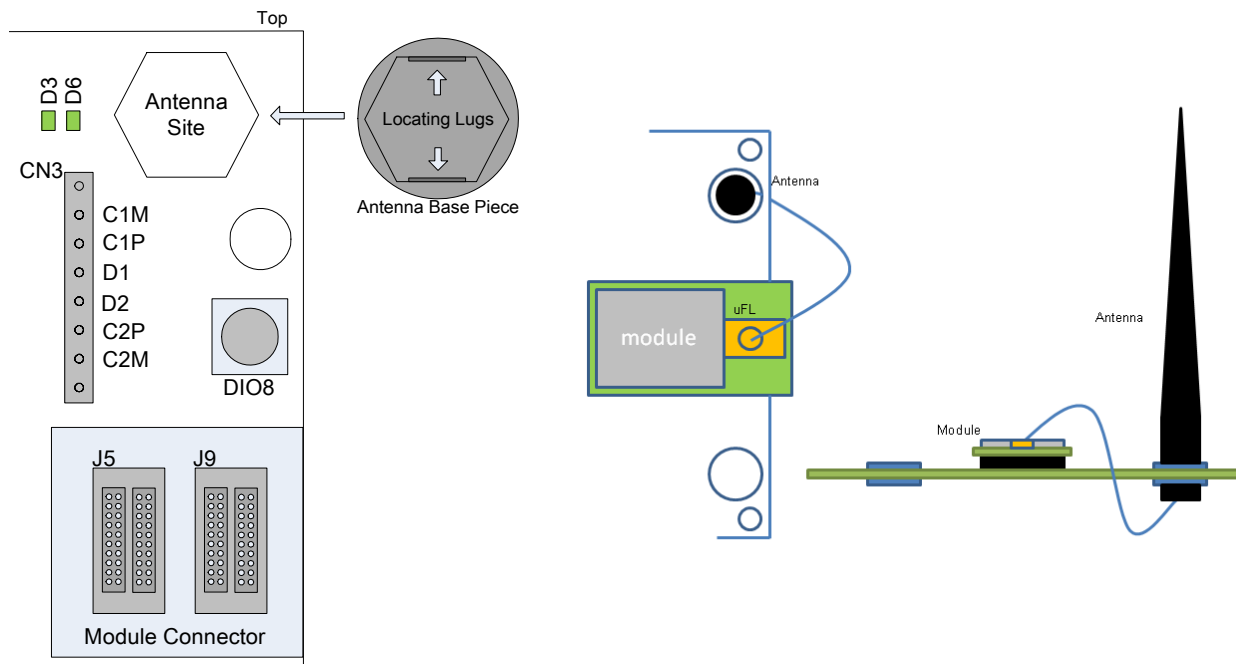

Figure 20: Antenna Mounting and Connection

1.3.7 USB Dongles (DR1198)

Two JN5168 USB Dongles (part number: DR1198) are supplied in the kit. One is intended for use in the JenNet-IP Smart Home Demonstration and the other can be employed in some other capacity, such as packet sniffing (see below).

The JN5168 USB Dongle has the following features:

- JN5168-001 wireless microcontroller (mounted directly on the board)
- Integrated PCB antenna
- FTDI FT232 driver chip for USB connection



Figure 21: DR1198 JN5168 USB Dongle

The two dongles are pre-programmed with identical software for the JenNet-IP Smart Home Demonstration. This software allows either dongle to be plugged into the USB port of the Linksys router (see [Section 1.3.8](#)) to form a 'Border-Router':

- The dongle provides the interface with the wireless network (WPAN) side of the demonstration system, also acting as the network Co-ordinator
- The Linksys router provides the interface with the IP (LAN/WAN) side of the demonstration system

For more details of the demonstration system, refer to [Section 1.4](#).

The dongles can be re-programmed with other applications. Firmware re-programming of the JN5168 USB Dongles is described in [Appendix B.3](#).



Note 1: A USB Dongle should not be plugged directly into a USB port of the Linksys router but connected to a USB port via the USB extension cable supplied with the router. This facilitates improved radio performance.

Note 2: Since both dongles are identical, it does not matter which one you choose to use with the Linksys router. You may wish to re-program the other dongle, e.g. as a packet sniffer based on the Ubilogix Ubiqua software advertised in the evaluation kit box (the file **JennicSniffer_JN5168_1000000_HP.bin**, provided in all the JN516x SDKs, must be loaded into the dongle).

1.3.8 Linksys Router

The Linksys Wireless-N Broadband Router (WRT160NL) is supplied in the kit along with accessories consisting of:

- 12V DC power supply unit (universal type)
- 2 antennas with SMA connectors
- RJ45 Ethernet cable
- USB extension cable

The router and its accessories are shown in [Figure 22](#) below (the JN5168 USB Dongle shown is also supplied in the kit - see below).



Figure 22: Linksys Router and Accessories



Caution: *The external PSU acts as a disconnect device to isolate the equipment from the mains supply. It should also be noted that it depends on over-current protection of the building installation.*

The supplied Linksys router has been pre-programmed with an NXP firmware upgrade which allows the router to operate in a JenNet-IP system. The router is used in conjunction with a JN5168 USB dongle (see [Section 1.3.7](#)) to provide an interface between the wireless network (WPAN) side and the IP (LAN/WAN) side of the system, where the latter is one of:

- Wired IP or Ethernet bus (possibly connected to the Internet)
- Wi-Fi network (possibly connected to the Internet)

These two implementations are illustrated in [Figure 23](#) below.

1 **Note 1:** The JN5168 USB Dongle (see [Section 1.3.7](#)) should not be plugged directly into a USB port of the Linksys router but connected to a USB port via the supplied USB extension cable. This facilitates improved radio performance of the dongle.

Note 2: Wi-Fi is disabled by default on the supplied Linksys router. If required, it must be enabled.

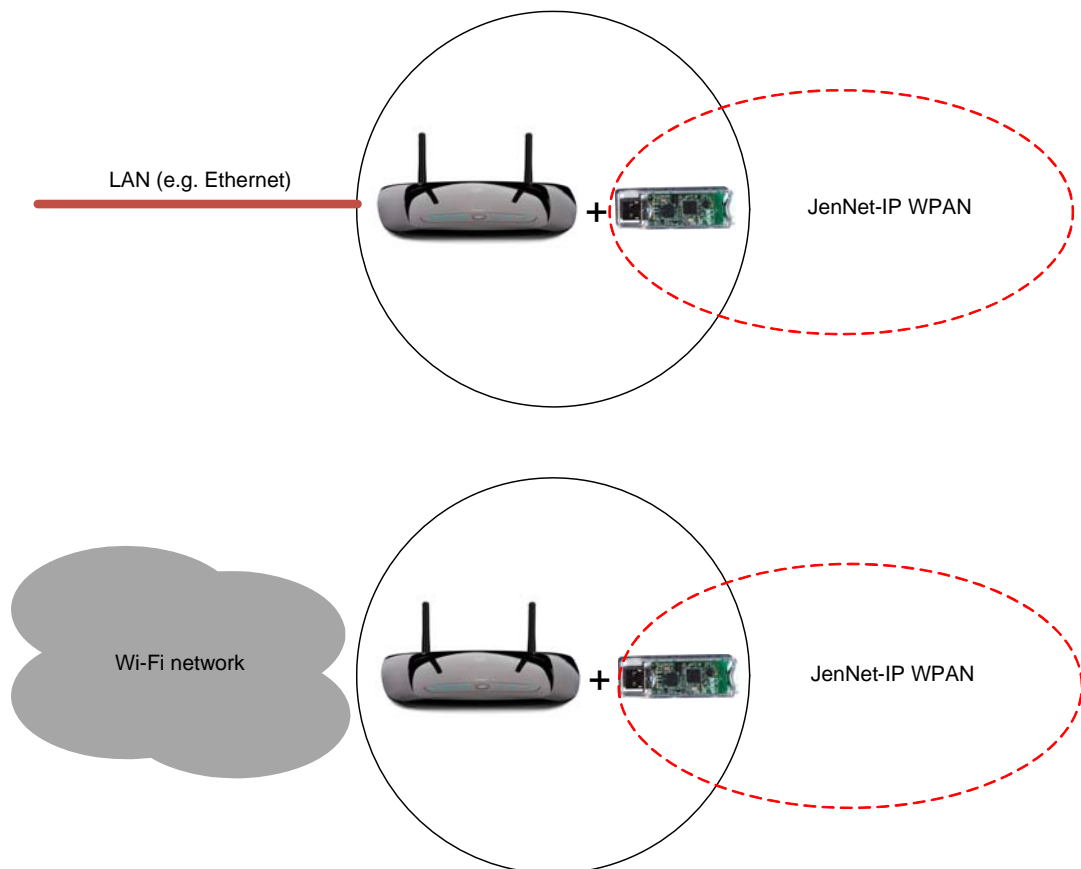

Figure 23: Linksys Router Implementation

Together, the Linksys router and USB dongle form a 'Border-Router' for the system:

- The Linksys router provides the interface with the IP (LAN/WAN) side of the JenNet-IP system
- The JN5168 USB Dongle provides the interface with the wireless network (WPAN) side of the JenNet-IP system, also acting as the network Co-ordinator

1.4 Smart Home Demonstration

Certain components of the kit are pre-loaded with the software for the JenNet-IP Smart Home Demonstration. Running this demonstration will allow you to test most components of the kit (even if you do not intend to use the JenNet-IP protocol to develop your own applications).

The demonstration is a lighting system which allows LEDs on the nodes/boards of the wireless network (WPAN) to be controlled in either of two ways:

- From outside the WPAN, via an IP connection from a PC
- From within the WPAN, from a wireless Remote Control Unit

The demonstration system is depicted below. More detailed information and instructions on how to run the demonstration are provided in [Chapter 3](#).

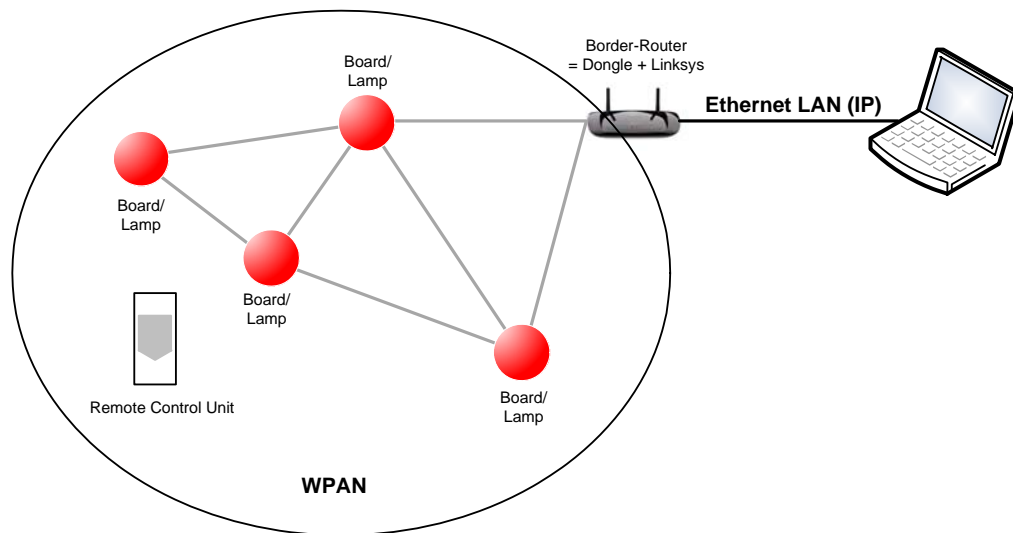

Figure 24: JenNet-IP Smart Home Demo System



Note 1: If you are already experienced with wireless networks, you may wish to now run the demonstration by going straight to [Chapter 3](#). Otherwise, you may wish to first familiarise yourself with the key wireless network concepts by reading [Chapter 2](#).

Note 2: The demonstration application code is described in the *JenNet-IP Smart Home Application Note (JN-AN-1162)*, which also contains the relevant source and binary files.

Chapter 1
Introduction to the Evaluation Kit

2. Wireless Network Concepts

Before setting up a wireless network and running the supplied demonstration, you are advised to study the background information on wireless networks presented in this chapter. Only the basic concepts that are essential to using the evaluation kit and demonstration are covered here - they are:

- Radio frequency - see [Section 2.1](#)
- Node types - see [Section 2.2](#)
- Network identification - see [Section 2.3](#)
- Network formation and topology - see [Section 2.4](#)
- Software stack - see [Section 2.5](#)

The concepts covered are relevant to all the wireless network protocols supported by the JN516x-EK001 Evaluation Kit - that is, JenNet-IP, ZigBee PRO and ZigBee RF4CE. Note that all of these protocols are built on IEEE 802.15.4, which is also supported on its own. For a more complete introduction to wireless networks, refer to the manual for the relevant protocol (see [Section 4.3](#)).

2.1 Radio Frequency

The JN5168-based devices of the evaluation kit communicate in the 2400-MHz radio frequency (RF) band. This is one of the standard RF bands used by the IEEE 802.15.4 wireless network protocol (on which all the supported protocols are based), and is available for unlicensed use in most geographical areas (check your local radio communication regulations).

The 2400-MHz band spans radio frequencies 2400 to 2483.5 MHz and is divided into 16 channels, numbered 11 to 26 (the numbers up to 10 are used for other RF bands) - see [Figure 25](#) below.

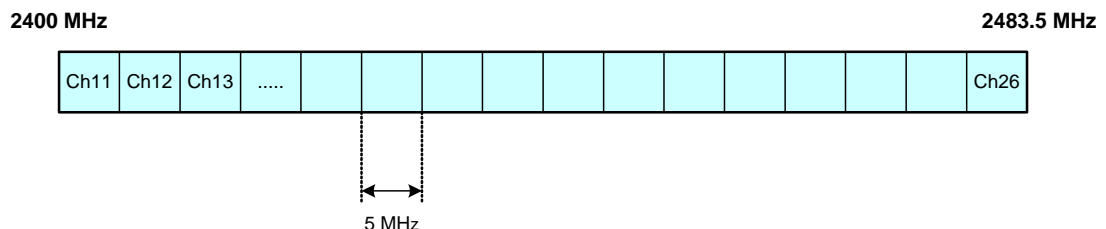

Figure 25: 2400-MHz RF Band

The channel of operation for a network can be specified by the application or, alternatively, the network can search for the best channel (the one with least detected activity) at system start-up.

2.2 Node Types

In addition to running an application (e.g. temperature measurement), each node of a wireless network has a networking role. Most IEEE 802.15.4-based networks can contain three types of node, differentiated by their networking roles, as described below (ZigBee RF4CE is an exception):

Node Type	Description
Co-ordinator	A wireless network has one and only one Co-ordinator, or PAN Co-ordinator. This node has a role in starting and forming the network, and can also have a routing role (passes messages from one node to another). Messages can also originate and terminate here.
Router	This node passes messages from one node to another. Messages can also originate and/or terminate at a Router. This node type is also sometimes referred to as a Local Co-ordinator.
End Device	This node is simply a place where messages can originate and/or terminate (the node does not have a routing role). In order to conserve power, an End Device can sleep when it is not required to be active.

Table 2: Node Types in a Wireless Network

The roles of the above node types will become more apparent in [Section 2.4](#) on network topologies.

2.3 Network Identification

A wireless network must have a unique identifier which allows it to be distinguished from other networks in the same operating neighbourhood. IEEE 802.15.4-based protocols use a 16-bit value called the PAN ID. This identifier is used by the lower levels of the software stack to identify the network - for example, in the delivery of messages sent between nodes. It can be pre-defined in the user application or chosen by the PAN Co-ordinator, but it must not clash with the PAN ID of a neighbouring network.

A wireless network protocol may also use its own network identifier (in addition to the PAN ID) - for example, in the JenNet-IP protocol, a 32-bit Network Application ID is implemented at the application level.

2.4 Network Formation and Topology

A wireless network is formed as follows:

1. The first node to be started is the Co-ordinator, which performs network initialisation including the selection of the radio channel in which the network will operate (see [Section 2.1](#)) and the PAN ID of the network (see [Section 2.3](#)).
2. Once the initialisation is complete, the Co-ordinator allows other nodes to join it as its 'children' - the Co-ordinator is referred to as a 'parent'. These child nodes can be Routers and/or End Devices.
3. Each Router may itself become a parent by allowing child nodes to join it (which may themselves be Routers and/or End Devices). In this way, the network grows.

A number of network shapes or topologies are possible, which are dependent on the wireless network protocol used. These are the Star, Tree and Mesh topologies, described in the sub-sections below.

2.4.1 Star Networks

A Star network contains only one routing node, which is the Co-ordinator. Thus, all messages between the network nodes are routed via the central Co-ordinator.

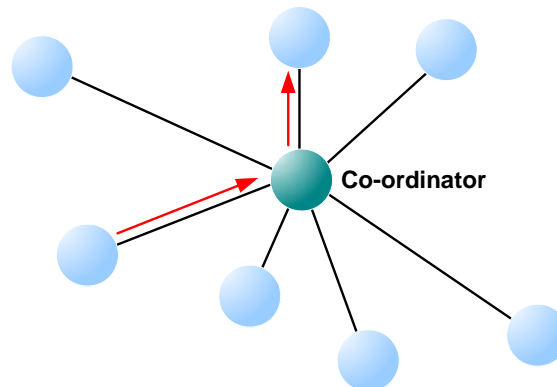

Figure 26: Star Network

2.4.2 Tree Networks

A Tree network may contain the full range of node types - Co-ordinator, Routers and End Devices - with the Co-ordinator at the top of the (inverted) tree. Any node can only communicate directly with its parent and children (if any). Thus, a message for a remote node must be passed up the tree until it can be passed down to its destination.

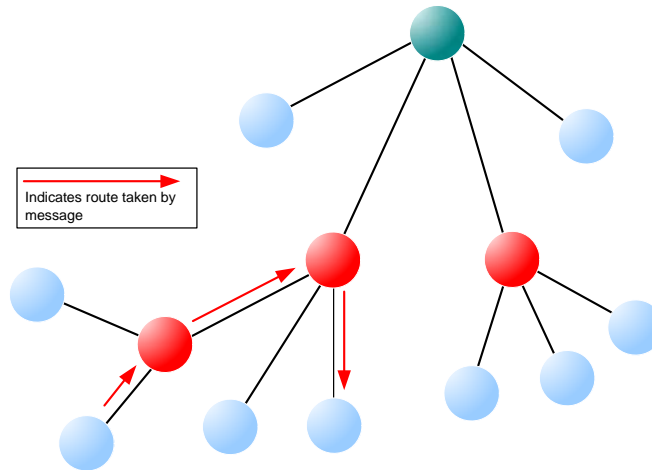

Figure 27: Tree Network

2.4.3 Mesh Networks

A Mesh network may contain the full range of node types - Co-ordinator, Routers and End Devices. Any routing node (Router or Co-ordinator) can communicate directly with any other routing node within radio range. However, an End Device can only communicate directly with its parent. When sending a message between two nodes that cannot communicate directly, the message is routed via intermediate routing nodes (for which there may be more than one possible route).

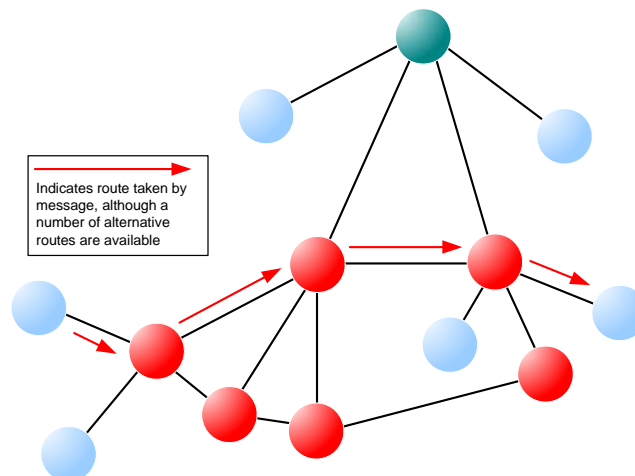

Figure 28: Mesh Topology

2.5 Wireless Network Protocol Stack

The software which runs on a wireless network node deals with both application-specific tasks (e.g. temperature measurement) and networking tasks (e.g. assembling a message to send to another node). The software on a node is organised as a number of layers, forming a stack, with the user application at the top. The basic layers of a wireless network protocol stack are typically as illustrated in [Figure 29](#) below.

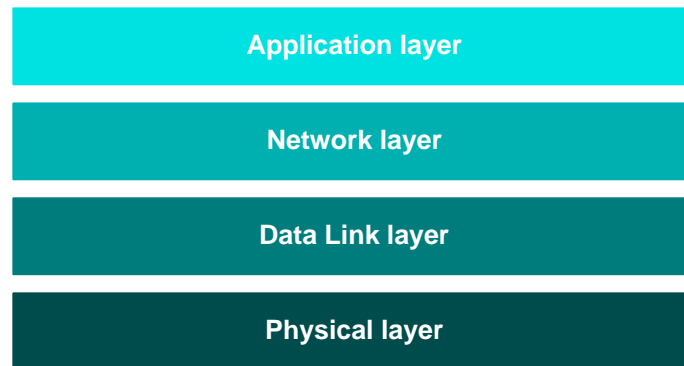

Figure 29: Basic Layers of Stack

The stack layers are outlined below, from top to bottom:

- **Application layer:** Contains the user applications which run on the network node and provides an interface to the lower layers
- **Network layer:** Provides the networking functionality and an interface to the IEEE 802.15.4 layers (see below) - for example, this layer could be provided by the ZigBee PRO protocol, but is not required for a pure IEEE 802.15.4 network
- **Data Link layer:** Provided by the MAC (Media Access Control) layer of the IEEE 802.15.4 standard, and responsible for message assembly/disassembly and addressing (e.g. specifying the destination of outgoing messages)
- **Physical layer:** Provided by the PHY (Physical) layer of the IEEE 802.15.4 standard and concerned with interfacing to the physical transmission medium (radio, in this case)

A number of C APIs (Application Programming Interfaces) are provided to allow a user application to easily interact with the layers of the stack. The required APIs depend on the protocol used (IEEE 802.15.4, JenNet-IP, ZigBee PRO or ZigBee RF4CE) and are supplied in the relevant NXP Software Developer's Kit (SDK) - see [Section 4.1](#).

The software components that implement the Data Link and Physical layers of the stack are pre-programmed in on-chip ROM. The user application is developed and built on a PC. The resulting application binary file also incorporates the Network layer of the stack and is loaded into the Flash memory of the node.

In order to use the JenNet-IP Smart Home Demonstration which is pre-loaded in the JN516x-EK001 Evaluation Kit boards, no knowledge of the JenNet-IP software is required. However, you should familiarise yourself with the software for your chosen protocol before starting your own application development - refer to [Section 4.3](#) for details of the user documentation for the different protocols.

Chapter 2
Wireless Network Concepts

3. Smart Home Demonstration

The chapter describes how to use the contents of the JN516x-EK001 Evaluation Kit to set up and run the pre-loaded JenNet-IP Smart Home Demonstration.



Note 1: The procedure in this chapter provides a ‘quick start’ to setting up and using the demonstration. For further information and more detailed instructions on this demonstration, refer to the Application Note *JenNet-IP Smart Home (JN-AN-1162)*, available from the NXP Wireless Connectivity TechZone (see “[Support Resources](#)” on page 6).

Note 2: This demonstration is based on the JenNet-IP protocol and will allow you test most of the components provided in the kit. Demonstrations based on the other supported protocols are available from NXP as Application Notes, which can be loaded and run using this evaluation kit - see [Section 4.3](#).

3.1 Demo System Overview

This JenNet-IP Smart Home Demonstration is based on a wireless network (WPAN) with nodes containing lights, which may be monitored and controlled as follows:

- wirelessly from a Remote Control Unit within the WPAN
- via an IP connection from a remote device on a LAN or WAN (e.g. from a PC)

The demonstration system is illustrated in [Figure 30](#).

The following components of the JN516x-EK001 Evaluation Kit are used in the demonstration (for detailed descriptions of the components, refer to [Section 1.3](#)):

- **Carrier Boards with Pre-fitted Expansion Boards:** Each board assembly can act as a node of the WPAN and is pre-programmed as a WPAN Router. The lights to be controlled are as follows:
 - **Lighting/Sensor Expansion Boards (3):** Three White LEDs
 - **Generic Expansion Board (1):** LED D2



Caution: *The LEDs on the Lighting/Sensor Expansion Boards are very bright at maximum intensity. To avoid damage to your eyes, do not look into them directly for an extended period of time.*

Chapter 3
Smart Home Demonstration

- **Remote Control Unit:** This unit initially behaves as a WPAN Router until it has joined the network and then acts as a 'sleepy broadcaster'. In the latter mode, the device sleeps and only wakes when it is needed to broadcast control commands (it does not have the role of a conventional WPAN node). If sleeping, the unit must be activated using the Wake (blue circle) button below the keypad before any other keys are pressed - refer to [Appendix A](#).
- **JN5168 USB Dongle:** Either dongle can be connected to the Linksys router (via the USB extension cable). Together they provide the Border-Router which is the interface between the WPAN and LAN/WAN domains - the dongle handles the WPAN side of this interface. It is also the WPAN Co-ordinator.
- **Linksys Router:** This device has been pre-programmed with an NXP firmware upgrade for JenNet-IP. It should be connected to a JN5168 USB Dongle (via the USB extension cable). Together they provide the Border-Router which is the interface between the WPAN and LAN/WAN domains - the router handles the LAN/WAN side of this interface and connects to the Ethernet bus on which the controlling PC is located.

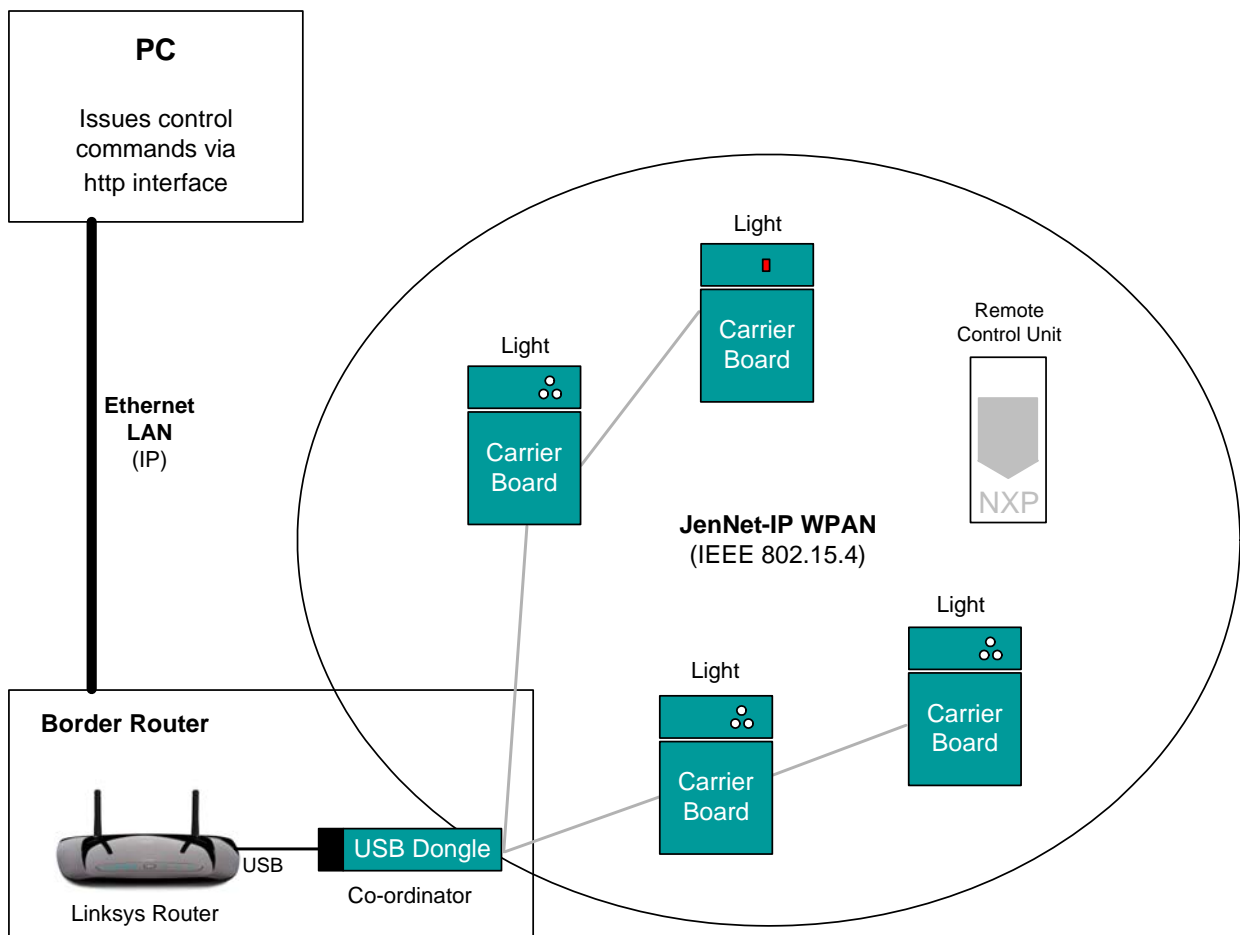

Figure 30: Smart Home Demo System

The WPAN will have a tree topology but its precise topology cannot be pre-determined since the network is formed dynamically. One or more of the Routers may be leaf-nodes of the tree, in which case their routing capability will not be used.

3.2 Setting Up and Operating the Demo System

This section describes how to set up the demo system using the evaluation kit components.

Step 1 Connect the PC to the Linksys router

- a) Boot up the PC.
- b) Use the supplied Ethernet cable to connect the PC to the Linksys router (but do not power on the Linksys router yet). *Use a blue Ethernet socket on the router (do not use the yellow socket labelled 'Internet').*

Step 2 Connect a JN5168 USB Dongle to the Linksys router

Connect a JN5168 USB Dongle (which is programmed as a Border-Router and as a WPAN Co-ordinator) to the USB socket of the Linksys router via the supplied USB extension cable (use of this cable improves the radio performance of the dongle).



Step 3 Power on the Linksys router

Connect the power supply to the Linksys router. The unit will automatically power on (this will also start the JN5168 USB Dongle). The power LED will first flash and then the central LED will flash. The unit is ready when the central LED stops flashing and remains illuminated.

Since the JN5168 USB Dongle will also be the Co-ordinator of the WPAN, this device will create a network, for the moment consisting of just the Co-ordinator - the rest of the network will be formed later.

Step 4 Access the JenNet-IP Border-Router Configuration interface from the PC

- a) Launch a web browser on the PC.
- b) Access the JenNet-IP Border-Router Configuration interface on the Linksys router by entering the following IP address into the browser:

<http://192.168.11.1/>

- c) On the resulting web page, log in with username `root` and password `snap`.

Step 5 Display the 'whitelist' of WPAN nodes in the interface on the PC

In the interface, select the **JenNet-IP** tab and then select the **Whitelist** sub-tab. Normally, this sub-tab shows a list of the detected WPAN nodes, identified by their IPv6 addresses, as illustrated in the screenshot below. Those nodes that are ticked (in the checkbox on the left-hand side) are in the whitelist and so are allowed into the network.

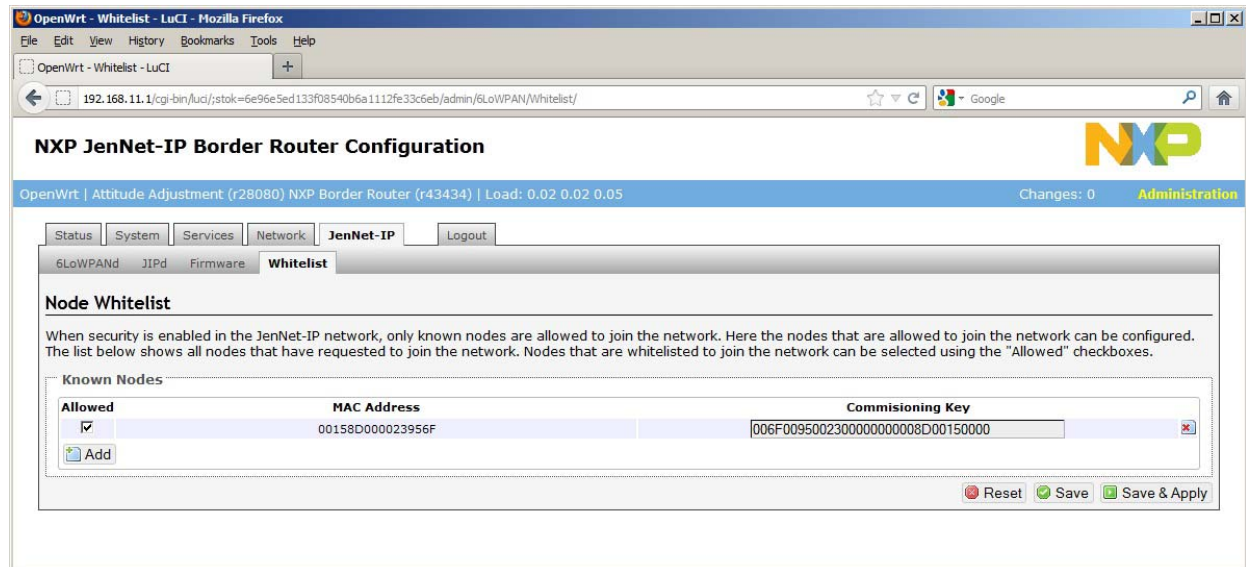

Step 6 Start a board and add the node to the whitelist

Perform the following for just one board:

- a) On a Carrier Board fitted with a JN5168 module with uFL connector, install one of the supplied push-through antennae onto the board and connect the attached fly lead to the uFL connector on the module (this installation is fully described in [Section 1.3.6.1](#)). This is not necessary for a module with an integrated antenna.
- b) Insert four of the supplied AAA batteries onto the rear of the Carrier Board (the required polarities are indicated on the board). Also ensure that the batteries have been selected as the power source for the board, with the jumper **J4** in the **BAT** position (as described in [Section 1.3.2.1](#)). Note the following:
 - On power-up, the node will attempt to join the WPAN (for which the JN5168 USB Dongle is the Co-ordinator).
 - While the node is trying to join the network, the three white LEDs on a Lighting/Sensor Expansion Board or LED D2 on the Generic Expansion Board will be fully illuminated.



Caution: *The LEDs on the Lighting/Sensor Expansion Boards are very bright at maximum intensity. To avoid damage to your eyes, do not look into them directly for an extended period of time.*

- There is no timeout on the node's attempt to find and join the WPAN, *but the node will not be able to join until it has been whitelisted (see below).*



Note: If the board has previously been used, it will retain settings (e.g. PAN ID) from the previous network to which it belonged. To clear this information and return to the factory settings, perform a factory reset as follows: *Wait at least 2 seconds following power-up and then press the Reset button on the Carrier Board 4 times with less than 2 seconds between two consecutive presses.* After the reset, the board will try to join a new network.

- c) On the PC, refresh the web page showing the **Whitelist** tab in the browser. The new node should now appear in the list but will be unticked (greylisted). If the node fails to show in the list, you are advised to power off the board (e.g. remove the batteries) and re-start it (from Step 6b).
- d) Make a note of the node's IPv6 address and relate it to the physical node, for identification purposes later on (you may wish to label the node with the address).
- e) Put the node into the whitelist by ticking its checkbox on the left-hand side. If you have prior knowledge of the node's IEEE/MAC address and commissioning key, you can enter these details in the box revealed by clicking the **Add** button.
- f) Click the **Save & Apply** button. The node should now be able to join the network. Once the node has joined the network, the three white LEDs or LED D2 (depending on the board) will flash twice to indicate this and then remain fully illuminated.

Step 7 Start the next board (if any)

If there are still boards to be started, start the next one as described in Step 6.

Step 8 Start the Remote Control Unit and add it to the whitelist

- a) Remove the battery compartment slide-cover on the rear of the Remote Control Unit and insert two of the supplied AAA batteries (the required polarities are indicated inside the battery compartment). Then replace the cover. Note the following:
 - On installing the batteries, the unit will automatically power up.
 - The unit will then attempt to join the WPAN that has been created by the JN5168 USB Dongle (Co-ordinator) attached to the Linksys router.
 - The left LED on the Remote Control Unit will flash twice per second while the unit is trying to join the network, *but the unit will not be able to join until it has been whitelisted (see below).*



Note 1: If the Remote Control Unit has been previously used, it will remember the last network to which it belonged. To clear this information and return to the factory settings, enter the following key sequence into the unit: **# 0 - 0**

Chapter 3 Smart Home Demonstration

- b) On the PC, refresh the web page showing the **Whitelist** tab in the browser. The new node should now appear in the list but will be unticked (greylisted). If the node fails to show in the list, you are advised to power off the board (e.g. remove the batteries) and re-start it (from Step 8a).
- c) Make a note of the node's IPv6 address and relate it to the physical node, for identification purposes later on (you may wish to label the node with the address).
- d) Put the node into the whitelist by ticking its checkbox on the left-hand side. If you have prior knowledge of the node's IEEE/MAC address and commissioning key, you can enter these details in the box revealed by clicking the **Add** button.
- e) Click the **Save & Apply** button. The node should now be able to join the network.

Step 9 Use the Remote Control Unit to control the lights on the boards

- a) Press the Wake (blue circle) button, located below the keypad, to wake up the sleeping Remote Control Unit.

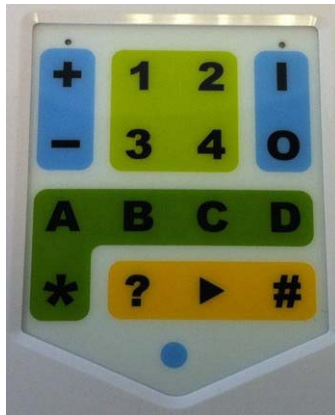

- b) Enter a command sequence on the keypad - for example:
 - To switch off all the lights in the network, enter: * O
 - To switch on all the lights in the network, enter: * I
 - To dim all the lights in the network, enter: * - (hold down the '-' key)
 - To brighten all the lights in the network, enter: * + (hold down the '+' key)



Note: All the available key operations and command sequences for the Remote Control Unit are listed and described in [Appendix A](#).

Step 10 Control the lights on the boards from the PC via IP

- a) Access the Smart Devices interface on the Linksys router by directing the web browser on the PC to the following (case-sensitive) IP address:

http://192.168.11.1/cgi-bin/SmartDevices.cgi

- b) On the Smart Devices page, click on the **Global Control** tab, which contains a set of controls that can be used to control all the network nodes simultaneously.



- c) Use the controls as follows:

- Switch off the lights by clicking the **Off** box
- Switch on the lights by clicking the **On** box
- Vary the brightness of the lights (dimmer operation) using the vertical slider in the green bar (to the right to brighten, to the left to dim) - this is achieved by clicking the desired location in the bar (rather than moving the vertical slider)

- d) Now click on the **Individual Control** tab, which contains a similar set of controls for each individual board (identified by its IPv6 address next to its name), and perform the various control operations on individual lights.



Tip: Light (nodes) can be put into groups and a control command can be issued for a whole group, either from the Remote Control Unit or the PC. Group control is described the Application Note *JenNet-IP Smart Home (JN-AN-1162)*.

Chapter 3
Smart Home Demonstration

4. Where Next?

Once you have set up and run the pre-loaded Smart Home Demonstration, you may wish to start developing your own wireless network applications to run on the components of the JN516x-EK001 Evaluation Kit. This chapter helps you to get started in this application development, as follows:

- [Section 4.1](#) provides information on the available wireless network protocols for your JN516x application development.
- [Section 4.2](#) outlines the NXP Software Developer's Kits (SDKs) that are available to support application development using the different protocols.
- [Section 4.3](#) directs you to the user documentation for each protocol.

4.1 Which Protocol?

The JN516x-EK001 Evaluation Kit supports four protocols that can be used to develop applications for the JN516x wireless microcontroller:

- **IEEE 802.15.4:** This is an industry-standard protocol which provides the low-level functionality for implementing wireless network communications. The other supported protocols are built on top of IEEE 802.15.4, but an application can also be designed to interface directly with the IEEE 802.15.4 stack layers and an API is provided to facilitate this interaction. Developing an application directly on top of IEEE 802.15.4 requires lower level programming than using one of the other supported protocols.
- **JenNet-IP:** This is an NXP proprietary protocol which allows wireless networks to be implemented that can be accessed via IP (e.g. from a PC, tablet or smart phone on the Internet). APIs are provided to facilitate the interaction between the application and the JenNet-IP stack. A typical application is lighting control, as illustrated by the JenNet-IP Smart Home Demonstration.
- **ZigBee PRO:** This is an industry-standard protocol which provides a Network stack layer (over IEEE 802.15.4) that supports Mesh networking. APIs are provided to facilitate the interaction between the application and the ZigBee PRO stack. These APIs must be used in conjunction with the APIs of JenOS (Jennic Operating System). Three ZigBee 'application profiles' are provided for use with ZigBee PRO (APIs are provided to aid application coding):
 - **Smart Energy (SE):** This profile is concerned with the management and monitoring of power consumption (and other resources) in a building.
 - **Home Automation (HA):** This profile is concerned with the control of a range of technology in the home, including lighting and security.
 - **ZigBee Light Link (ZLL):** This profile is concerned with the control of the lighting in a building.
- **ZigBee RF4CE:** This is an industry-standard protocol which is targeted at IEEE 802.15.4-based wireless remote control applications (e.g. the control of a home media system). APIs are provided to facilitate the interaction between the application and the ZigBee RF4CE stack.

4.2 Software Developer's Kit (SDK)

NXP provide Software Developer's Kits (SDKs) to facilitate the development of JN516x wireless network applications on a PC. These SDKs include Application Programming Interfaces (APIs) and development tools, and are supplied in the installers listed below. You will need two installers: the SDK Toolchain (JN-SW-4041) and the SDK installer for your chosen wireless network protocol.

- SDK Toolchain (JN-SW-4041) - needed for all application development
- IEEE 802.15.4 SDK (JN-SW-4063)
- JenNet-IP SDK (JN-SW-4065)
- ZigBee Smart Energy SDK (JN-SW-4064)
- ZigBee Home Automation SDK (JN-SW-4067)
- ZigBee Light Link SDK (JN-SW-4062)
- ZigBee RF4CE SDK (JN-SW-4060)



Note: The software required to develop applications directly on the IEEE 802.15.4 stack layers is actually included in the JN516x SDKs for all the protocols.

All of the above SDK installers can be downloaded free-of-charge from the NXP Wireless Connectivity TechZone (see [“Support Resources” on page 6](#)). Installation instructions for the SDKs are provided in the *SDK Installation and User Guide (JN-UG-3064)*, which is also available from the TechZone.

The contents of the above SDKs are outlined in the sub-sections below.

4.2.1 SDK Toolchain (JN-SW-4041)

The SDK Toolchain is essential for all application development for the JN516x devices and must be installed first, before the SDK for your chosen protocol.

This installer includes the following:

- Eclipse IDE (Integrated Development Environment)
- JN51xx compiler for use by the Eclipse platform to build applications
- JN51xx Flash programmer to load built applications into nodes
- Cygwin CLI (Command Line Interface)

Application development for the JN516x device using any of the protocols is intended to be conducted in the Eclipse Integrated Development Environment (IDE), which is supplied in the NXP SDK Toolchain. It is, however, possible to develop your application code using another editor and to build it from the command line using makefiles.

4.2.2 IEEE 802.15.4 SDK (JN-SW-4063)

The IEEE 802.15.4 SDK includes the IEEE 802.15.4 stack software and the following APIs:

- 802.15.4 Stack API for developing wireless network applications
- Application Queue API for optional use in conjunction with the above API
- JN516x Integrated Peripherals API for interacting with on-chip peripherals
- LPRF Board API for interacting with evaluation kit board resources

4.2.3 JenNet-IP SDK (JN-SW-4065)

The JenNet-IP SDK includes the relevant stack software, and the following APIs and applications:

- JenNet-IP WPAN APIs for developing applications for the WPAN domain
- JenNet-IP LAN/WAN APIs for developing applications for the LAN/WAN domain
- JenNet-IP Border-Router applications
- JenNet-IP Browser (Java version)
- JenOS Persistent Data Manager (PDM) API for storing and retrieving context data in non-volatile memory
- 802.15.4 Stack API
- JN516x Integrated Peripherals API for interacting with on-chip peripherals
- LPRF Board API for interacting with evaluation kit board resources

4.2.4 ZigBee Smart Energy SDK (JN-SW-4064)

The ZigBee Smart Energy SDK includes the ZigBee PRO stack software, the Smart Energy (SE) profile and the following APIs:

- ZigBee PRO APIs for developing wireless network applications
- Smart Energy API for incorporating SE functionality in applications
- JenOS APIs for interacting with the RTOS and system management modules
- 802.15.4 Stack API
- JN516x Integrated Peripherals API for interacting with on-chip peripherals
- LPRF Board API for interacting with evaluation kit board resources
- ZPS and JenOS Configuration Editors (NXP plug-ins for Eclipse)

4.2.5 ZigBee Home Automation SDK (JN-UG-4067)

The ZigBee Home Automation SDK includes the ZigBee PRO stack software, the Home Automation (HA) profile and the following APIs:

- ZigBee PRO APIs for developing wireless network applications
- Home Automation API for incorporating HA functionality in applications
- JenOS APIs for interacting with the RTOS and system management modules
- 802.15.4 Stack API
- JN516x Integrated Peripherals API for interacting with on-chip peripherals
- LPRF Board API for interacting with evaluation kit board resources
- ZPS and JenOS Configuration Editors (NXP plug-ins for Eclipse)

4.2.6 ZigBee Light Link SDK (JN-SW-4062)

The ZigBee Light Link SDK includes the ZigBee PRO stack software, the ZigBee Light Link (ZLL) profile and the following APIs:

- ZigBee PRO APIs for developing wireless network applications
- ZigBee Light Link API for incorporating ZLL functionality in applications
- JenOS APIs for interacting with the RTOS and system management modules
- 802.15.4 Stack API
- JN516x Integrated Peripherals API for interacting with on-chip peripherals
- LPRF Board API for interacting with evaluation kit board resources
- ZPS and JenOS Configuration Editors (NXP plug-ins for Eclipse)

4.2.7 ZigBee RF4CE SDK (JN-SW-4060)

The ZigBee RF4CE SDK includes the ZigBee RF4CE stack software and the following APIs:

- ZigBee RF4CE API for developing wireless remote control applications
- ZigBee Remote Control (ZRC) application profile API
- ZigBee Input Device (ZID) application profile API
- 802.15.4 Stack API
- JN516x Integrated Peripherals API for interacting with on-chip peripherals
- LPRF Board API for interacting with evaluation kit board resources

4.3 User Documentation

A dedicated documentation set is provided for each of the supported protocols (IEEE 802.15.4, JenNet-IP, ZigBee PRO and ZigBee RF4CE). This documentation is available from the NXP Wireless Connectivity TechZone (see “Support Resources” on page 6).

The user documentation for each protocol is detailed in the following sub-sections:

- IEEE 802.14.5 documentation in [Section 4.3.1](#)
- JenNet-IP documentation in [Section 4.3.2](#)
- ZigBee PRO/Smart Energy documentation in [Section 4.3.3](#)
- ZigBee PRO/Home Automation documentation in [Section 4.3.4](#)
- ZigBee PRO/ZigBee Light Link documentation in [Section 4.3.5](#)
- ZigBee RF4CE documentation in [Section 4.3.6](#)

Navigation through the documentation sets is summarised in [Figure 31](#) below.

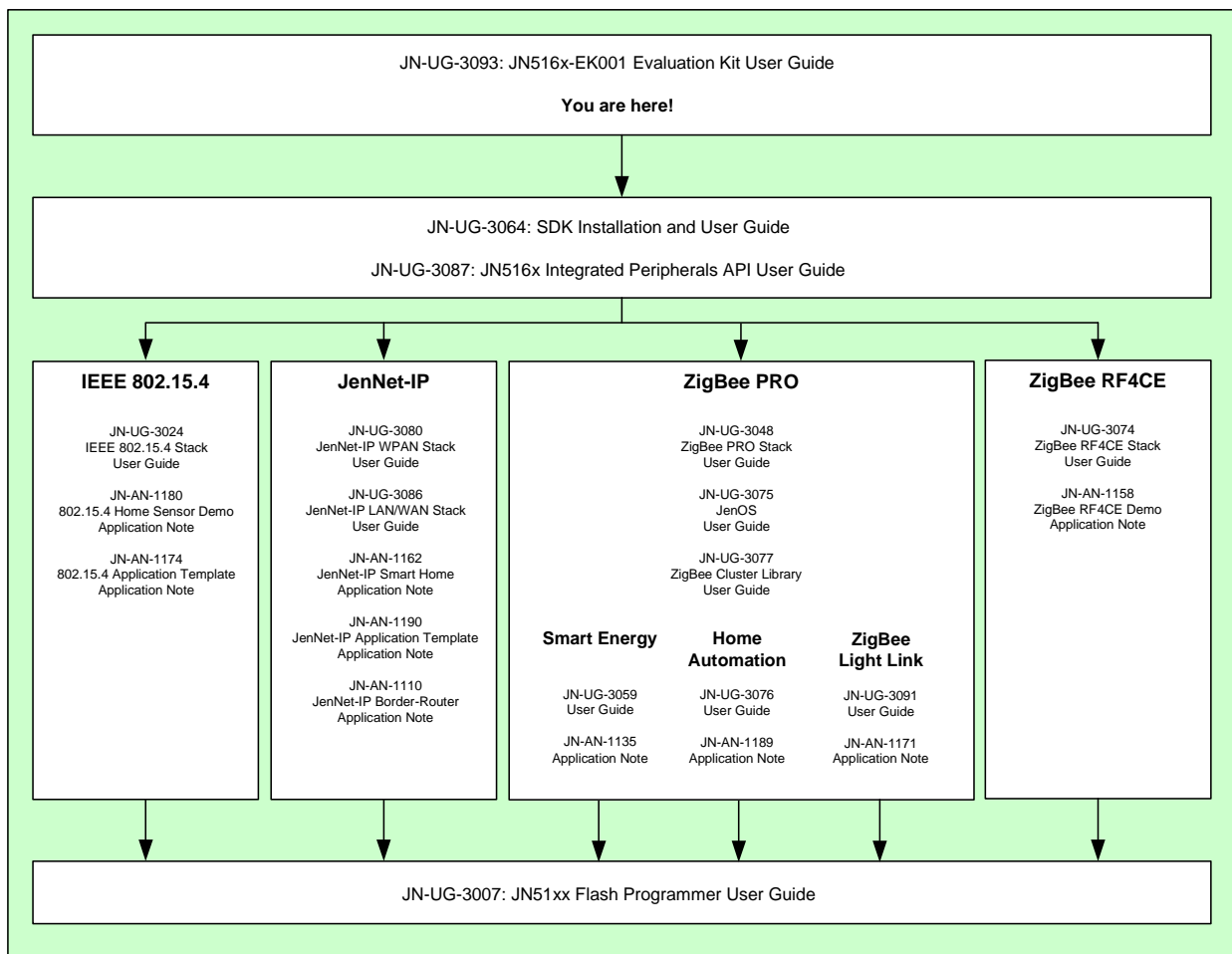

Figure 31: Documentation Flow

4.3.1 IEEE 802.15.4 Documentation

A complete list of the user documentation relevant to IEEE 802.15.4 is provided in Table 3 on page 50.

If you intend to develop pure IEEE 802.15.4 applications:

1. First study Part I of the *IEEE 802.15.4 Stack User Guide (JN-UG-3024)* to familiarise yourself with essential IEEE 802.15.4 concepts.
2. During application development, you should refer to the above User Guide for details of the API resources to use.

In addition, there are two key Application Notes that you will find particularly useful when starting to develop your own applications:

- *802.15.4 Home Sensor Demonstration for JN516x (JN-AN-1180)* provides the code of the IEEE 802.15.4 Home Sensor Demonstration application and describes the application. This demonstration application also illustrates implementation of the optional IEEE 802.15.4 MAC-level security.
- *IEEE 802.15.4 Application Template (JN-AN-1174)* provides a skeleton application as a starting point for your own application coding. Use of this template is described in the *IEEE 802.15.4 Stack User Guide (JN-UG-3024)*.

Part Number	Document Title	Description
Application Coding		
JN-UG-3024	IEEE 802.15.4 Stack User Guide	Introduces IEEE 802.15.4 and details the software resources for developing wireless network applications that run directly on the IEEE 802.15.4 stack layers.
JN-AN-1180	802.15.4 Home Sensor Demonstration for JN516x	Application Note containing the application code of the 802.15.4 Home Sensor Demonstration for JN516x devices.
JN-AN-1174	IEEE 802.15.4 Application Template	Application Note containing a template from which to start 802.15.4 application coding. Use of the template is described in the User Guide JN-UG-3024 (above).
JN-UG-3087	JN516x Integrated Peripherals API User Guide	Details the JN516x Integrated Peripherals API, used in application code to interact with on-chip peripherals.
JN-RM-2003	LPRF Board API Reference Manual	Details the Board API, used in application code to interact with components on the boards supplied in the evaluation kit.
Development Tools		
JN-UG-3064	SDK Installation and User Guide	Describes how to install the Software Developer's Kit (SDK) and how to use the Eclipse development platform.
JN-UG-3007	JN51xx Flash Programmer User Guide	Describes how to use the JN51xx Flash Programmer.

Table 3: IEEE 802.15.4 User Documentation

4.3.2 JenNet-IP Documentation

A complete list of the user documentation relevant to JenNet-IP is provided in Table 4 on page 52.

If you intend to develop JenNet-IP applications:

1. First study Part I of the *JenNet-IP WPAN Stack User Guide (JN-UG-3080)* to familiarise yourself with essential JenNet-IP concepts.
2. During application development, the User Guide to be used for reference depends on which domain of the JenNet-IP system you are concerned with:
 - If you are developing for the WPAN domain, you should refer to the *JenNet-IP WPAN Stack User Guide (JN-UG-3080)*.
 - If you are developing for the LAN/WAN domain, you should refer to the *JenNet-IP LAN/WAN Stack User Guide (JN-UG-3086)*.

In addition, there are three key Application Notes that you will find particularly useful when starting to develop your own applications:

- *JenNet-IP Smart Home (JN-AN-1162)* provides an illustration of a JenNet-IP application (this is the demonstration pre-loaded in the JN516x-EK001 evaluation kit and described earlier in this manual).
- *JenNet-IP Application Template (JN-AN-1190)* provides a skeleton application as a starting point for your own application coding for a JenNet-IP WPAN.
- *JenNet-IP Border-Router (JN-AN-1110)* details how to develop your own Border-Router, which provides the interface between the LAN/WAN and WPAN domains.

Part Number	Document Title	Description
Application Coding		
JN-UG-3080	JenNet-IP WPAN Stack User Guide	Provides a general introduction to JenNet-IP and details the software resources for developing applications that run on devices on the WPAN (IEEE 802.15.4) side of a JenNet-IP system
JN-UG-3086	JenNet-IP LAN/WAN Stack User Guide	Details the software resources for developing applications that run on IP hosts on the LAN/WAN side of a JenNet-IP system
JN-AN-1162	JenNet-IP Smart Home Application Note	Describes the application code of the JenNet-IP Smart Home demonstration
JN-AN-1190	JenNet-IP Application Template	Contains a template from which to start JenNet-IP WPAN application coding.
JN-AN-1110	JenNet-IP Border-Router Application Note	Details how to design a custom JenNet-IP Border-Router device (for users who do not wish to use the NXP-supplied Border-Router)
JN-UG-3087	JN516x Integrated Peripherals API User Guide	Details the JN516x Integrated Peripherals API, used in application code to interact with on-chip peripherals.
JN-RM-2003	LPRF Board API Reference Manual	Details the Board API, used in application code to interact with components on the boards supplied in the evaluation kit
Development Tools		
JN-UG-3064	SDK Installation and User Guide	Describes how to install the Software Developer's Kit (SDK) and how to use the Eclipse development platform.
JN-UG-3007	JN51xx Flash Programmer User Guide	Describes how to use the JN51xx Flash Programmer.

Table 4: JenNet-IP User Documentation

4.3.3 ZigBee PRO/Smart Energy Documentation

A complete list of the user documentation relevant to ZigBee PRO with the Smart Energy (SE) profile is provided in [Table 5](#) below.

If you intend to develop ZigBee SE applications:

1. First study Part I of each of the following User Guides in order to familiarise yourself with the relevant concepts:
 - *ZigBee PRO Stack User Guide (JN-UG-3048)*
 - *ZigBee Smart Energy API User Guide (JN-UG-3059)*
 - *JenOS User Guide (JN-UG-3075)*
2. During application development, you should refer to the above three User Guides for details of the API resources to use, as well as to the *ZigBee Cluster Library User Guide (JN-UG-3077)*.

In addition, during application development you should refer to the Application Note *Smart Energy HAN Solutions (JN-AN-1135)* for examples of SE applications.

Part Number	Document Title	Description
Application Coding		
JN-UG-3048	ZigBee PRO Stack User Guide	Introduces essential ZigBee PRO concepts and details the ZigBee PRO APIs for developing applications.
JN-UG-3075	JenOS User Guide	Details the JenOS APIs used in ZigBee PRO application code to manage OS resources.
JN-UG-3059	ZigBee PRO Smart Energy API User Guide	Introduces ZigBee Smart Energy (SE) and details the SE API for developing applications.
JN-UG-3077	ZigBee Cluster Library User Guide	Describes the NXP implementation of the ZigBee Cluster Library (ZCL).
JN-AN-1135	Smart Energy HAN Solutions	Application Note which provides example Smart Energy Home Area Network solutions.
JN-UG-3087	JN516x Integrated Peripherals API User Guide	Details the JN516x Integrated Peripherals API, used in application code to interact with on-chip peripherals.
JN-RM-2003	LPRF Board API Reference Manual	Details the functions and associated resources used to interact with components on the boards supplied in the evaluation kit.
Development Tools		
JN-UG-3064	SDK Installation and User Guide	Describes how to install the Software Developer's Kit (SDK) and how to use the Eclipse development platform.
JN-UG-3007	JN51xx Flash Programmer User Guide	Describes how to use the JN51xx Flash Programmer.

Table 5: ZigBee PRO/SE User Documentation

4.3.4 ZigBee PRO/Home Automation Documentation

A complete list of the user documentation relevant to ZigBee PRO with the Home Automation (HA) profile is provided in [Table 6](#) below.

If you intend to develop HA applications:

1. First study Part I of each of the following User Guides in order to familiarise yourself with the relevant concepts:
 - *ZigBee PRO Stack User Guide (JN-UG-3048)*
 - *ZigBee Home Automation User Guide (JN-UG-3076)*
 - *JenOS User Guide (JN-UG-3075)*
2. During application development, you should refer to the above three User Guides for details of the API resources to use, as well as to the *ZigBee Cluster Library User Guide (JN-UG-3077)*.

In addition, during application development you should refer to the Application Note *ZigBee Home Automation Demonstration (JN-AN-1189)* for an example of an HA application.

Part Number	Document Title	Description
Application Coding		
JN-UG-3048	ZigBee PRO Stack User Guide	Introduces essential ZigBee PRO concepts and details the ZigBee PRO APIs for developing applications.
JN-UG-3075	JenOS User Guide	Details the JenOS APIs used in ZigBee PRO application code to manage OS resources.
JN-UG-3076	ZigBee Home Automation User Guide	Introduces ZigBee Home Automation (HA) and details the HA API for developing applications.
JN-UG-3077	ZigBee Cluster Library User Guide	Describes the NXP implementation of the ZigBee Cluster Library (ZCL).
JN-AN-1189	ZigBee Home Automation Demonstration	Application Note which provides an example ZigBee Home Automation application.
JN-UG-3087	JN516x Integrated Peripherals API User Guide	Details the JN516x Integrated Peripherals API, used in application code to interact with on-chip peripherals.
JN-RM-2003	LPRF Board API Reference Manual	Details the functions and associated resources used to interact with components on the boards supplied in the evaluation kit.
Development Tools		
JN-UG-3064	SDK Installation and User Guide	Describes how to install the Software Developer's Kit (SDK) and how to use the Eclipse development platform.
JN-UG-3007	JN51xx Flash Programmer User Guide	Describes how to use the JN51xx Flash Programmer.

Table 6: ZigBee PRO/HA User Documentation

4.3.5 ZigBee PRO/ZigBee Light Link Documentation

A complete list of the user documentation relevant to ZigBee PRO with the ZigBee Light Link (ZLL) profile is provided in [Table 7](#) below.

If you intend to develop ZLL applications:

1. First study Part I of each of the following User Guides in order to familiarise yourself with the relevant concepts:
 - *ZigBee PRO Stack User Guide (JN-UG-3048)*
 - *ZigBee Light Link User Guide (JN-UG-3091)*
 - *JenOS User Guide (JN-UG-3075)*
2. During application development, you should refer to the above three User Guides for details of the API resources to use, as well as to the *ZigBee Cluster Library User Guide (JN-UG-3077)*.

In addition, during application development you should refer to the Application Note *ZigBee Light Link Solution (JN-AN-1171)* for an example of a ZLL application.

Part Number	Document Title	Description
Application Coding		
JN-UG-3048	ZigBee PRO Stack User Guide	Introduces essential ZigBee PRO concepts and details the ZigBee PRO APIs for developing applications.
JN-UG-3075	JenOS User Guide	Details the JenOS APIs used in ZigBee PRO application code to manage OS resources.
JN-UG-3091	ZigBee Light Link User Guide	Introduces ZigBee Light Link (ZLL) and details the ZLL API for developing applications.
JN-UG-3077	ZigBee Cluster Library User Guide	Describes the NXP implementation of the ZigBee Cluster Library (ZCL).
JN-AN-1171	ZigBee Light Link Solution	Application Note which provides an example ZigBee Light Link application.
JN-UG-3087	JN516x Integrated Peripherals API User Guide	Details the JN516x Integrated Peripherals API, used in application code to interact with on-chip peripherals.
JN-RM-2003	LPRF Board API Reference Manual	Details the functions and associated resources used to interact with components on the boards supplied in the evaluation kit.
Development Tools		
JN-UG-3064	SDK Installation and User Guide	Describes how to install the Software Developer's Kit (SDK) and how to use the Eclipse development platform.
JN-UG-3007	JN51xx Flash Programmer User Guide	Describes how to use the JN51xx Flash Programmer.

Table 7: ZigBee PRO/ZLL User Documentation

4.3.6 ZigBee RF4CE Documentation

A complete list of the user documentation relevant to ZigBee RF4CE is provided in [Table 8](#) below.

If you intend to develop ZigBee RF4CE applications:

1. First study Part I of the *ZigBee RF4CE Stack User Guide (JN-UG-3074)* to familiarise yourself with essential ZigBee RF4CE concepts.
2. During application development, you should refer to the above User Guide for details of the API resources to use.

In addition, during application development you should refer to the Application Note *ZigBee RF4CE Demonstration (JN-AN-1158)* for an example of a ZigBee RF4CE application.

Part Number	Document Title	Description
Application Coding		
JN-UG-3074	ZigBee RF4CE Stack User Guide	Introduces essential ZigBee RF4CE concepts and details the ZigBee RF4CE APIs for developing applications.
JN-AN-1158	ZigBee RF4CE Demonstration	Application Note which provides an example ZigBee RF4CE application.
JN-UG-3087	JN516x Integrated Peripherals API User Guide	Details the JN516x Integrated Peripherals API, used in application code to interact with on-chip peripherals.
JN-RM-2003	LPRF Board API Reference Manual	Details the functions and associated resources used to interact with components on the boards supplied in the evaluation kit.
Development Tools		
JN-UG-3064	SDK Installation and User Guide	Describes how to install the Software Developer's Kit (SDK) and how to use the Eclipse development platform.
JN-UG-3007	JN51xx Flash Programmer User Guide	Describes how to use the JN51xx Flash Programmer.

Table 8: ZigBee RF4CE User Documentation

Appendices

A. Remote Control Operations in the Demonstration

In the pre-loaded JenNet-IP Smart Home Demonstration, control commands can be entered into the Remote Control Unit and wirelessly broadcast (in IEEE 802.15.4 packets) to the WPAN nodes.

[Table 9](#) below provides a summary of the use of individual keys by the demonstration and [Figure 32](#) shows the keypad of the Remote Control Unit. A complete list of the operations that can be performed from the keypad is provided in [Table 10 on page 58](#).

Key	Function	Description
I	ON	Switch on light(s)
O	OFF	Switch off light(s)
+	UP	Increase brightness of light(s)
-	DOWN	Decrease brightness of light(s)
#	PRG	Programming mode
*	ALL	All groups
A	GRP	Group A
B		Group B
C		Group C
D		Group D
•	Wake	Wake Remote Control Unit from sleep

Table 9: Key Functions on Remote Control Unit



Figure 32: Keypad of Remote Control Unit

Appendices

The table below summarises the key sequences and associated operations that can be performed from the Remote Control Unit in the JenNet-IP Smart Home demo.

Operation	Key Sequence	
Switch on lights in selected group	GRP ON ALL ON	A/B/C/D I * I
Switch off lights in selected group	GRP OFF ALL OFF	A/B/C/D O * O
Increase brightness of lights in selected group (increase occurs while key UP [+] key is pressed). If a light is off, it is switched on.	GRP UP ALL UP	A/B/C/D + * +
Decrease brightness of lights in selected group (decrease occurs while key DOWN [-] key is pressed). If a light is off, command has no effect.	GRP DOWN ALL DOWN	A/B/C/D - * -
Add nodes (within radio range) to the specified group (the radio is put in a low-power mode for this operation)	PRG UP ON GRP/ALL	# + I A/B/C/D/*
Commission and then add nodes (within radio range) to the specified group as well as to the 'All' group.	PRG ON OFF ON GRP	# I O I A/B/C/D
Commission and then add nodes (within radio range) to the 'All' group only.	PRG ON OFF ON ALL	# I O I *
Remove nodes (within radio range) from the specified group (the radio is put in a low-power mode for this operation)	PRG DOWN OFF GRP/ALL	# - O A/B/C/D/*
Remove nodes (within radio range) from the specified group.	PRG OFF ON OFF GRP	# O I O A/B/C/D
Remove nodes (within radio range) from the 'All' group only.	PRG OFF ON OFF ALL	# O I O *
Commission a Border-Router (within radio range) to learn network settings in extending standalone WPAN to full JIP system	PRG ON OFF ON OFF	# I O I O
Commission an additional Remote Control Unit (within radio range) to act as an independent Remote Control Unit for WPAN.	PRG ON OFF ON DOWN	# I O I -
Commission an additional Remote Control Unit (within radio range) to act as a cloned Remote Control Unit for WPAN.	PRG ON OFF ON UP	# I O I +
Try to join an existing WPAN.	PRG UP DOWN UP	# + - +
Create a standalone WPAN.	PRG DOWN UP DOWN	# - + -
Perform a factory reset.	PRG OFF DOWN OFF	# O - O
Perform a software reset.	PRG ON UP ON	# I + I

Table 10: Remote Control Key Sequences and Associated Operations

I = ON O = OFF + = UP - = DOWN # = PRG * = ALL GRP = A, B, C or D



Note: In normal operation, the Remote Control Unit sleeps until it is needed. It should be woken by pressing the Wake (blue circle) button before entering any of the above command sequences on the keypad.

B. Firmware Re-programming

The following components of the JN516x-EK001 Evaluation Kit are supplied already programmed with the JenNet-IP Smart Home Demonstration but can be re-programmed with other applications:

- Remote Control Unit - see [Appendix B.1](#)
- JN5168 modules (on Carrier Boards) - see [Appendix B.2](#)
- JN5168 USB Dongle - see [Appendix B.3](#)

B.1 Re-programming Remote Control Unit

The firmware of the Remote Control Unit can be re-programmed using the supplied Programming Dongle (part number: DR1128). This re-programming is conducted as follows:

1. Remove the battery compartment cover on the rear of the unit to reveal the J3 header for the Programming Dongle (if there are batteries in the compartment, you can leave them or remove them).



2. Insert the Programming Dongle onto the header in the battery compartment, as illustrated below.



3. Use one of the supplied 'USB A to Mini B' cables to connect the USB Mini B port on the Programming Dongle to a USB port of your PC (you may be prompted to install the device driver for the FTDI chip which is located on the dongle - if this is the case, refer to [Appendix B.4](#)).
4. Use the JN51xx Flash Programmer application on your PC to load the new firmware image into the Remote Control Unit. You must use the standalone JN51xx Flash Programmer tool (JN-SW-4007), which is available from the NXP Wireless Connectivity TechZone (see "[Support Resources](#)" on page 6). The programming procedure is described in the *JN51xx Flash Programmer User Guide (JN-UG-3007)*, but ignore references to resetting the device and putting it into programming mode - for the dongle, this is done automatically.
5. Once programming has completed, remove the Programming Dongle and replace the battery compartment cover.



Note: The Programming Dongle can also be used as a UART port on the Remote Control Unit for debug purposes.

B.2 Re-programming JN5168 Modules

In order to re-program the Flash memory of the supplied JN5168 modules, you must connect the Carrier Board (on which the module is located) to your PC (see below). To perform the re-programming from your PC, you must use the standalone version of the JN51xx Flash Programmer utility (JN-SW-4007), which is available from the NXP Wireless Connectivity TechZone (see "[Support Resources](#)" on page 6). The programming procedure is described in the *JN51xx Flash Programmer User Guide (JN-UG-3007)*.

When re-programming the JN516x modules on the Carrier Boards in this kit, you must use one of the supplied 'USB A to Mini B' cables to connect a USB port of your PC to the USB Mini B port of the Carrier Board. When you make this connection for the first time, you may be prompted to install the device driver for the FTDI chip which is located on the Carrier Board - if this is the case, refer to [Appendix B.4](#).

B.3 Re-programming JN5168 USB Dongles

In order to re-program the Flash memory of the supplied JN5168 USB Dongles, you must plug the dongle into a USB port of PC (see below). To perform the re-programming from your PC, you must use the standalone version of the JN51xx Flash Programmer utility (JN-SW-4007), which is available from the NXP Wireless Connectivity TechZone (see "[Support Resources](#)" on page 6). The programming procedure is described in the *JN51xx Flash Programmer User Guide (JN-UG-3007)*.

When you make the USB connection for the first time, you may be prompted to install the device driver for the FTDI chip which is located on the dongle - if this is the case, refer to [Appendix B.4](#).

B.4 Installing the FTDI Device Driver for USB Connections

The first time that you make a USB connection between your PC and a kit component which features the FTDI FT232 chip, you may be prompted to install the device driver for the chip on your PC. This driver is provided in the SDK Toolchain (JN-SW-4041). The installation of this driver is described below (although you may not need this procedure if Windows automatically finds the required driver on the Internet).

1. When you make the USB connection, check whether **Found new hardware wizard for TTL232r-3v3** is displayed on your PC.

If this appears, you must install the driver by following the rest of this procedure. Otherwise, the driver is already installed.

2. Fill in the screen **Install from a specific location**, as follows:
 - a) Select the radio button **Search for the best driver in these locations**.
 - b) Tick the checkbox **Include this location in the search**.
 - c) Using the **Browse** button, navigate to the directory **FTDI_drivers** in the installed SDK on your PC. For example, if the SDK has been installed on drive C of your PC, the required path will be:

C:\Jennic\Tools\Drivers\FTDI_drivers

- d) Click **OK**.

The wizard will automatically fill in the details in the drop-down search box.

3. In the **Found new hardware wizard** screen, click **Next**.
4. Wait for the wizard as it searches for and installs the new driver. On completion, it will display the message "Completing the Found new hardware wizard". Click **Finish** to complete.

In some cases, you may need to repeat the procedure from Step 2, depending on your hardware configuration.

Finally, the **Found new hardware** bubble will indicate that the hardware is installed and ready for use.



Note: Alternatively, you can obtain the relevant driver for your operating system from the FTDI web page www.ftdichip.com/FTDrivers.htm. Go to the VCP drivers, download the required driver to your desktop and double-click on its icon to install.

C. Compliance Statements and Documentation

This appendix contains the FCC, Industry Canada and CE compliance statements and documentation for the components of the JN516x-EK001 Evaluation Kit:

[Appendix C.1](#) contains the FCC statements and documentation

[Appendix C.2](#) contains the Industry Canada statements

[Appendix C.3](#) contains the CE statements and documentation

C.1 FCC Statements and Documentation

This section contains the Federal Communication Commission (FCC) statements and documents.

TX FCC IDs of Kit Contents

The JN516x-EK001 Evaluation Kit contains the following TX FCC IDs:
TYOJN5168M0, TYOJN5168M3, TYOJN5168M5, TYOJN5168M6, TYOJN5168U0
and Q87-WRT160NL.

High-Power Module Usage Limitation

The high-power module variants are classified as 'mobile' devices pursuant with FCC §2.1091 and must not be used at a distance of less than 20 cm (8") from any person.

Federal Communication Commission Interference Statement

This equipment has been tested and found to comply with the limits for a Class B digital device, pursuant to Part 15 of the FCC Rules. These limits are designed to provide reasonable protection against harmful interference in a residential installation. This equipment generates, uses, and can radiate radio frequency energy and, if not installed and used in accordance with the instructions, may cause harmful interference to radio communications. However, there is no guarantee that interference will not occur in a particular installation. If this equipment does cause harmful interference to radio or television reception, which can be determined by turning the equipment off and on, the user is encouraged to try to correct the interference by one of the following measures:

- Reorient or relocate the receiving antenna.
- Increase the separation between the equipment and receiver.
- Connect the equipment into an outlet on a circuit different from that to which the receiver is connected.
- Consult the dealer or an experienced radio/TV technician for help.

This device complies with Part 15 of the FCC Rules. Operation is subject to the following two conditions: (1) This device may not cause harmful interference, and (2) this device must accept any interference received, including interference that may cause undesired operation.

FCC Caution: *Any changes or modifications not expressly approved by the party responsible for compliance could void the user's authority to operate this equipment.*

WARNING!

FCC Radiation Exposure Statement:

This portable equipment with its antenna complies with FCC's RF radiation exposure limits set forth for an uncontrolled environment. To maintain compliance follow the instructions below:

1. This transmitter must not be co-located or operating in conjunction with any other antenna or transmitter.
2. Avoid direct contact to the antenna, or keep it to a minimum while using this equipment.

For a list of approved antennas for use with the modules used in this kit, please refer to the appropriate module datasheet.

C.1.1 DR1128 FCC Documentation

FCC COMPLIANCE INFORMATION
STATEMENT
DECLARATION OF CONFORMITY



Manufacturer:	NXP Semiconductors Netherlands B.V
Responsible Party in the USA:	Niel P Smith NXP Semiconductors 411 E. Plumeria Drive San Jose CA 95134 USA Tel 001 408-518 5302
Product:	DR1128 Programming Dongle
Authorisation Procedure:	Declaration of Conformity

This device complies with Part 15 of the FCC Rules. Operation is subject to the following two conditions: (1) this device may not cause harmful interference, and (2) this device must accept any interference received, including interference that may cause undesired operation.

We, NXP Laboratories (UK) Ltd, have determined that the above named equipment has been shown to comply with the applicable technical standards. Furthermore, we warrant that each unit of equipment marketed is identical to the unit tested and found acceptable with the standards. The records maintained continue to reflect the equipment being produced within the variation that can be expected due to quantity production and testing on a statistical basis.

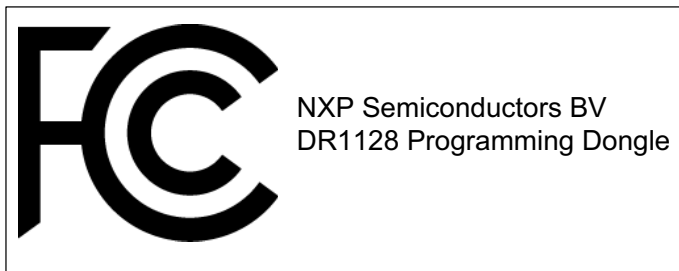

Sheffield, September 7th, 2012

Conrad Farlow, Senior RF Hardware Engineer, NXP Laboratories Ltd

C.1.2 DR1159 FCC Documentation

FCC COMPLIANCE INFORMATION
STATEMENT
DECLARATION OF CONFORMITY



NXP LABORATORIES (UK) LTD
FURNIVAL STREET
SHEFFIELD
S1 4QT
UNITED KINGDOM

TELEPHONE: +44 (0) 114 281 2655
FACSIMILE: +44 (0) 114 281 2951
WEB: www.nxp.com

Manufacturer:	NXP Semiconductors Netherlands B.V
Responsible Party in the USA:	Niel P Smith NXP Semiconductors 411 E. Plumeria Drive San Jose CA 95134 USA Tel 001 408-518 5302
Product:	DR1159 Remote Control Unit
Authorisation Procedure:	Declaration of Conformity

This device complies with Part 15 of the FCC Rules. Operation is subject to the following two conditions: (1) this device may not cause harmful interference, and (2) this device must accept any interference received, including interference that may cause undesired operation.

We, NXP Laboratories (UK) Ltd, have determined that the above named equipment has been shown to comply with the applicable technical standards. Furthermore, we warrant that each unit of equipment marketed is identical to the unit tested and found acceptable with the standards. The records maintained continue to reflect the equipment being produced within the variation that can be expected due to quantity production and testing on a statistical basis.

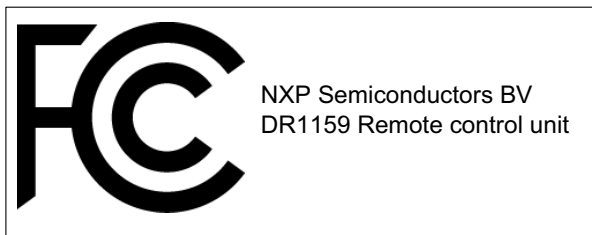

Sheffield, September 7th, 2012

Conrad Farlow, Senior RF Hardware Engineer, NXP Laboratories Ltd

C.1.3 DR1174 FCC Documentation

FCC COMPLIANCE INFORMATION
STATEMENT
DECLARATION OF CONFORMITY



Manufacturer:	NXP Semiconductors Netherlands B.V
Responsible Party in the USA:	Niel P Smith NXP Semiconductors 411 E. Plumeria Drive San Jose CA 95134 USA Tel 001 408-518 5302
Product:	DR1174 Carrier Board
Authorisation Procedure:	Declaration of Conformity

This device complies with Part 15 of the FCC Rules. Operation is subject to the following two conditions: (1) this device may not cause harmful interference, and (2) this device must accept any interference received, including interference that may cause undesired operation.

We, NXP Laboratories (UK) Ltd, have determined that the above named equipment has been shown to comply with the applicable technical standards. Furthermore, we warrant that each unit of equipment marketed is identical to the unit tested and found acceptable with the standards. The records maintained continue to reflect the equipment being produced within the variation that can be expected due to quantity production and testing on a statistical basis.



Sheffield, September 7th, 2012

Conrad Farlow, Senior RF Hardware Engineer, NXP Laboratories Ltd

C.1.4 DR1175 FCC Documentation

FCC COMPLIANCE INFORMATION
STATEMENT
DECLARATION OF CONFORMITY



NXP LABORATORIES (UK) LTD
FURNIVAL STREET
SHEFFIELD
S1 4QT
UNITED KINGDOM

TELEPHONE: +44 (0) 114 281 2655
FACSIMILE: +44 (0) 114 281 2951
WEB: www.nxp.com

Manufacturer:	NXP Semiconductors Netherlands B.V
Responsible Party in the USA:	Niel P Smith NXP Semiconductors 411 E. Plumeria Drive San Jose CA 95134 USA Tel 001 408-518 5302
Product:	DR1175 Lighting/Sensor Expansion Board
Authorisation Procedure:	Declaration of Conformity

This device complies with Part 15 of the FCC Rules. Operation is subject to the following two conditions: (1) this device may not cause harmful interference, and (2) this device must accept any interference received, including interference that may cause undesired operation.

We, NXP Laboratories (UK) Ltd, have determined that the above named equipment has been shown to comply with the applicable technical standards. Furthermore, we warrant that each unit of equipment marketed is identical to the unit tested and found acceptable with the standards. The records maintained continue to reflect the equipment being produced within the variation that can be expected due to quantity production and testing on a statistical basis.

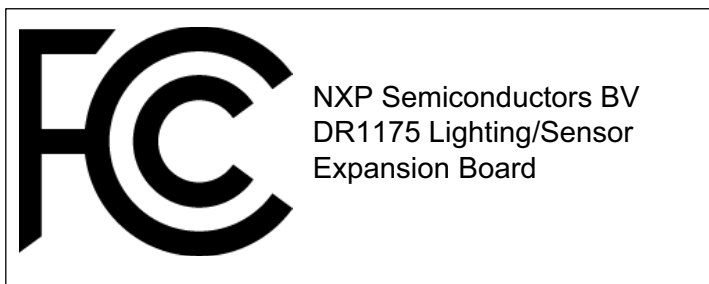

Sheffield, September 7th, 2012

Conrad Farlow, Senior RF Hardware Engineer, NXP Laboratories Ltd

C.1.5 DR1198 FCC Documentation

FCC COMPLIANCE INFORMATION
STATEMENT
DECLARATION OF CONFORMITY



Manufacturer:	NXP Semiconductors Netherlands B.V
Responsible Party in the USA:	Niel P Smith NXP Semiconductors 411 E. Plumeria Drive San Jose CA 95134 USA Tel 001 408-518 5302
Product:	DR1198 JN5168-001-U00 USB Dongle
Authorisation Procedure:	Declaration of Conformity

This device complies with Part 15 of the FCC Rules. Operation is subject to the following two conditions: (1) this device may not cause harmful interference, and (2) this device must accept any interference received, including interference that may cause undesired operation.

We, NXP Laboratories (UK) Ltd, have determined that the above named equipment has been shown to comply with the applicable technical standards. Furthermore, we warrant that each unit of equipment marketed is identical to the unit tested and found acceptable with the standards. The records maintained continue to reflect the equipment being produced within the variation that can be expected due to quantity production and testing on a statistical basis.

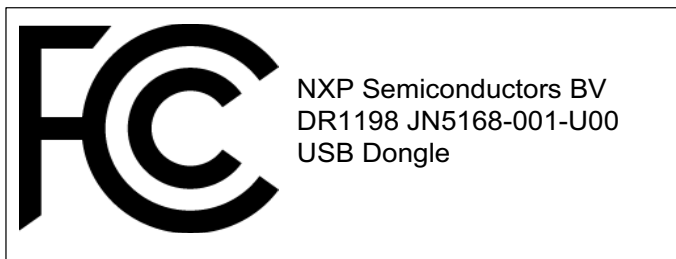

Sheffield, December 4th, 2012

Conrad Farlow, Senior RF Hardware Engineer, NXP Laboratories Ltd

C.1.6 DR1199 FCC Documentation

FCC COMPLIANCE INFORMATION
STATEMENT
DECLARATION OF CONFORMITY



NXP LABORATORIES (UK) LTD
FURNIVAL STREET
SHEFFIELD
S1 4QT
UNITED KINGDOM

TELEPHONE: +44 (0) 114 281 2655
FACSIMILE: +44 (0) 114 281 2951
E MAIL: info@jennic.com
WEB: www.jennic.com

Manufacturer:	NXP Semiconductors Netherlands B.V
Responsible Party in the USA:	Niel P Smith NXP Semiconductors 411 E. Plumeria Drive San Jose CA 95134 USA Tel 001 408-518 5302
Product:	DR1199 Generic Expansion Board
Authorisation Procedure:	Declaration of Conformity

This device complies with Part 15 of the FCC Rules. Operation is subject to the following two conditions: (1) this device may not cause harmful interference, and (2) this device must accept any interference received, including interference that may cause undesired operation.

We, NXP Laboratories (UK) Ltd, have determined that the above named equipment has been shown to comply with the applicable technical standards. Furthermore, we warrant that each unit of equipment marketed is identical to the unit tested and found acceptable with the standards. The records maintained continue to reflect the equipment being produced within the variation that can be expected due to quantity production and testing on a statistical basis.

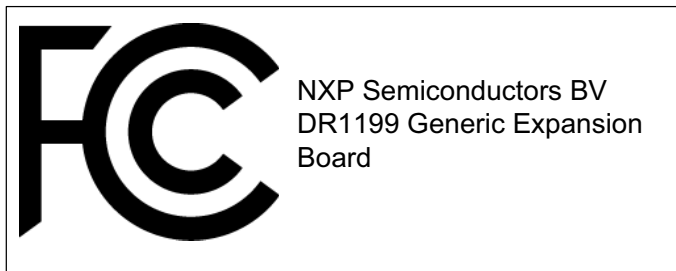

Sheffield, December 4th, 2012

Conrad Farlow, Senior RF Hardware Engineer, NXP Laboratories Ltd

C.1.7 DR1215 FCC Documentation

FCC COMPLIANCE INFORMATION
STATEMENT
DECLARATION OF CONFORMITY



NXP LABORATORIES (UK) LTD
 FURNIVAL STREET
 SHEFFIELD
 S1 4QT
 UNITED KINGDOM
 TELEPHONE: +44 (0) 114 281 2655
 FACSIMILE: +44 (0) 114 281 2951
 E MAIL: info@jennic.com
 WEB: www.jennic.com

Manufacturer:	NXP Semiconductors Netherlands B.V
Responsible Party in the USA:	Niel P Smith NXP Semiconductors 411 E. Plumeria Drive San Jose CA 95134 USA Tel 001 408-518 5302
Product:	DR1215 LCD Expansion Board
Authorisation Procedure:	Declaration of Conformity

This device complies with Part 15 of the FCC Rules. Operation is subject to the following two conditions: (1) this device may not cause harmful interference, and (2) this device must accept any interference received, including interference that may cause undesired operation.

We, NXP Laboratories (UK) Ltd, have determined that the above named equipment has been shown to comply with the applicable technical standards. Furthermore, we warrant that each unit of equipment marketed is identical to the unit tested and found acceptable with the standards. The records maintained continue to reflect the equipment being produced within the variation that can be expected due to quantity production and testing on a statistical basis.

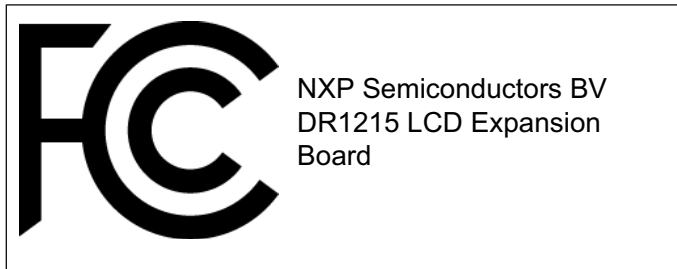

Sheffield, January 6th, 2014

Conrad Farlow, Senior RF Hardware Engineer, NXP Laboratories Ltd

C.2 Industry Canada Statements

This section contains the Industry Canada statements.

Industry Canada IDs of Kit Contents

The JN516x-EK001 Evaluation Kit contains the following Industry Canada IDs:
IC:7438A:CYOJN5168M0, IC:7438A:CYOJN5168M3, IC:7438A:CYOJN5168M5,
IC:7438A:CYOJN5168M6, IC:7438A:CYOJN5168U0 and IC:3839A-WRT160NL.

Industry Canada Statements

To reduce potential radio interference to other users, the antenna type and its gain should be so chosen that the equivalent isotropically radiated power (e.i.r.p.) is not more than that permitted for successful communication.

These modules have been designed to operate with antennas having a maximum gain of 2.2 dBi. antennas having a gain greater than 2.2 dBi are strictly prohibited for use with this device. The required antenna impedance is 50 ohms.

Class B Devices

The following Class B digital apparatus complies with Canadian ICES-003.

Ces appareils numériques de la classe B sont conformes à la norme NMB-003 du Canada.

- DR1128 Programming Dongle
- DR1159 Remote Control Unit
- DR1174 Carrier Board
- DR1175 Lighting/Sensor Expansion Board
- DR1198 JN5168 USB Dongle
- DR1199 Generic Expansion Board
- DR1215 LCD Expansion Board

C.3 CE Statements and Documentation

This section contains the CE (Conformité Européenne) statements and documents.

European R & TTE Directive 1999/5/EC Statement

All modules listed in this datasheet are compliant with ETSI EN 300 328 V1.7.1 (2006-10), EMC, EN 301 489-17 v2.1.1 (2009-02) and the Basic Safety Assessment (BSA) EN 60950-1:2006 (2006-06) and are subject to a Notified Body Opinion.

CE Documentation for All Kit Components

The CE documentation for all components of the JN516x-EK001 Evaluation Kit is shown below (2 pages).

**EC DECLARATION OF CONFORMITY TO R&TTE
DIRECTIVE 1995/5/EC & DIRECTIVE 2011/65/EU**



NXP LABORATORIES (UK) LTD
FURNIVAL STREET
SHEFFIELD
S1 4QT
UNITED KINGDOM

TELEPHONE: +44 (0) 114 281 2655
FACSIMILE: +44 (0) 114 281 2951
E MAIL: info@jennic.com
WEB: www.jennic.com

Manufacturer:	NXP Laboratories (UK) Ltd Furnival Street Sheffield S1 4QT
Product:	JN516x - EK001 Evaluation kit Containing the following components DR1128 Programming Dongle DR1159 Remote control unit DR1174 Carrier board DR1175 Lighting/Sensor Expansion Board DR1178 JN5168-001-M00 Module DR1180 JN5168-001-M03 Module DR1198 JN5168-001-U00 USB Dongle DR1199 Generic Expansion Board DR1200 JN5168-001-M05 10dBm Module DR1215 LCD Expansion Board Linksys WRT160NL Router
Conformity Assessment:	Annex III
Notified Bodies used:	0891 - TRaC Global
Certificate:	TBA

Reference standards and Directives used for presumption of conformity:

EMC	EN 301 489-1 V1.9.2; EN 301 489-17 V2.1.1
Radio	EN 300 328 V1.7.1 (2006)
Health & Safety	EN 60590-1: 2006, A1, A11, A12
Directive 2011/65/EU	Restriction on Hazardous Substances (RoHS)

Declaration

We, NXP Laboratories (UK) Ltd declare under our sole responsibility that the essential Safety, EMC and radio test suites have been carried out and that the above products to which this declaration relates are in conformity with all the applicable essential requirements of EU Directives 1995/5/EC and 2011/65/EU.

The product carries the CE Mark:



Sheffield, January 6th, 2014

A handwritten signature in black ink, appearing to read 'C Farlow'.

Conrad Farlow,
Senior Hardware Engineer, NXP Laboratories (UK) Ltd

Appendices

Revision History

Version	Date	Comments
1.0	07-Jan-2013	First release
1.1	25-Jan-2013	Minor updates/corrections made
1.2	15-Aug-2013	ZigBee Home Automation added and other modifications made
1.3	07-Jan-2014	LCD Expansion Board DR1201 replaced with DR1215
1.4	14-Feb-2014	IEEE 802.15.4 SDK and documentation details added

Important Notice

Limited warranty and liability - Information in this document is believed to be accurate and reliable. However, NXP Semiconductors does not give any representations or warranties, expressed or implied, as to the accuracy or completeness of such information and shall have no liability for the consequences of use of such information. NXP Semiconductors takes no responsibility for the content in this document if provided by an information source outside of NXP Semiconductors.

In no event shall NXP Semiconductors be liable for any indirect, incidental, punitive, special or consequential damages (including - without limitation - lost profits, lost savings, business interruption, costs related to the removal or replacement of any products or rework charges) whether or not such damages are based on tort (including negligence), warranty, breach of contract or any other legal theory.

Notwithstanding any damages that customer might incur for any reason whatsoever, NXP Semiconductors' aggregate and cumulative liability towards customer for the products described herein shall be limited in accordance with the *Terms and conditions of commercial sale* of NXP Semiconductors.

Right to make changes - NXP Semiconductors reserves the right to make changes to information published in this document, including without limitation specifications and product descriptions, at any time and without notice. This document supersedes and replaces all information supplied prior to the publication hereof.

Suitability for use - NXP Semiconductors products are not designed, authorized or warranted to be suitable for use in life support, life-critical or safety-critical systems or equipment, nor in applications where failure or malfunction of an NXP Semiconductors product can reasonably be expected to result in personal injury, death or severe property or environmental damage. NXP Semiconductors and its suppliers accept no liability for inclusion and/or use of NXP Semiconductors products in such equipment or applications and therefore such inclusion and/or use is at the customer's own risk.

Applications - Applications that are described herein for any of these products are for illustrative purposes only. NXP Semiconductors makes no representation or warranty that such applications will be suitable for the specified use without further testing or modification.

Customers are responsible for the design and operation of their applications and products using NXP Semiconductors products, and NXP Semiconductors accepts no liability for any assistance with applications or customer product design. It is customer's sole responsibility to determine whether the NXP Semiconductors product is suitable and fit for the customer's applications and products planned, as well as for the planned application and use of customer's third party customer(s). Customers should provide appropriate design and operating safeguards to minimize the risks associated with their applications and products.

NXP Semiconductors does not accept any liability related to any default, damage, costs or problem which is based on any weakness or default in the customer's applications or products, or the application or use by customer's third party customer(s). Customer is responsible for doing all necessary testing for the customer's applications and products using NXP Semiconductors products in order to avoid a default of the applications and the products or of the application or use by customer's third party customer(s). NXP does not accept any liability in this respect.

Export control - This document as well as the item(s) described herein may be subject to export control regulations. Export might require a prior authorization from competent authorities.

NXP Laboratories UK Ltd

(Formerly Jennic Ltd)
Furnival Street
Sheffield
S1 4QT
United Kingdom

Tel: +44 (0)114 281 2655

Fax: +44 (0)114 281 2951

For the contact details of your local NXP office or distributor, refer to:

www.nxp.com

For online support resources, visit the Wireless Connectivity TechZone:

www.nxp.com/techzones/wireless-connectivity